

T2 4K Series

Digital Recorder/Players



User Manual

Version 3.2.1

Copyright

Copyright 2012 – 2020 Grass Valley. All rights reserved. Portions of software © 2000 – 2020, Microsoft Corporation. All rights reserved. This document may not be copied in whole or in part, or otherwise reproduced except as specifically permitted under U.S. copyright law, without the prior written consent of Grass Valley, Inc., 125 Crown Point Court, Grass Valley, CA 95945. This product may be covered by one or more U.S. and foreign patents. Grass Valley is a trademark of GVBB Holdings S.a.r.l.

Disclaimer

- Product options and specifications subject to change without notice. The information in this manual is furnished for informational use only, is subject to change without notice, and should not be construed as a commitment by Grass Valley, Inc. Grass Valley, Inc. assumes no responsibility or liability for any errors or inaccuracies that may appear in this publication.
- The T2 4K Series's built-in display may sometimes have dead pixels, or always-on pixels. This is a specification within the liquid crystal display, and will not be considered as a fault or defect of the product. Also, If the T2 is connected to an external monitor, any dead or always-on pixels will depend on the specification of the external monitor.

U.S. Government Restricted Rights Legend

Use, duplication, or disclosure by the United States Government is subject to restrictions as set forth in subparagraph (c)(1)(ii) of the Rights in Technical Data and Computer Software clause at DFARS 252.277-7013 or in subparagraph c(1) and (2) of the Commercial Computer Software Restricted Rights clause at FAR 52.227-19, as applicable.

Trademarks and Logos

Grass Valley is a trademark of GVBB Holdings S.a.r.l. Grass Valley USA, LLC products are covered by U.S. and foreign patents, issued and pending. Additional information regarding Grass Valley USA, LLC trademarks and other proprietary rights may be found at www.grassvalley.com. Other trademarks and logos used in this document are either registered trademarks or trademarks of the manufacturers or vendors of the associated products, such as Microsoft® Windows® operating system, Windows Media® player, Internet Explorer® internet browser, and SQL Server™.

QuickTime and QuickTime logo are trademarks used under licenses. QuickTime is a trademark registered in the United States and other countries.



Avid, Avid DNxHD, and Pro ToolsR are trademarks or registered trademarks of Avid Technology, Inc. or its subsidiaries in the United States.

Intel and Core i7 are the trademarks or registered trademarks of Intel Corporation or its subsidiaries in the United States of America and other countries.

HDV is a trademark of Sony Corporation and JVC KENWOOD Corporation.

XDCAM, XDCAM EX, MPEG HD422, SxS, XAVC, XAVC S and their logos are trademarks of Sony Corporation.

The terms HDMI and HDMI High-Definition Multimedia Interface, and the HDMI Logo are trademarks or registered trademarks of HDMI Licensing Administrator, Inc. in the United States and other countries.

Adobe and Adobe Premiere are either registered trademarks or trademarks of Adobe Systems Incorporated in the United States and/or other countries.

P2, AVCCAM, AVC-Intra, and AVC-Ultra are trademarks of Panasonic Corporation.

Final Cut Pro and Apple ProRes are trademarks of Apple Inc., registered in the U.S. and other countries.

AVCHD is a trademark of Panasonic Corporation and Sony Corporation.

ASIO is a trademark and software of Steinberg Media Technologies GmbH.

 **DOLBY**
DIGITAL PLUS. Manufactured under license from Dolby Laboratories. Dolby and the double-D symbol are trademarks of Dolby Laboratories. Confidential unpublished works. Copyright 2003-2012 Dolby Laboratories. All rights reserved.

Grass Valley Web Site

This public Web site contains all the latest manuals and documentation, and additional support information. Use the following URL.

<http://www.grassvalley.com>

Manual Explanation

- If there are any variations between the explanation in this manual and the actual application method, priority is given to the actual application method.
- This manual is a common manual for T2 4K Series (T2 4K Elite/T2 4K Pro/ T2 4K Express/ T2 4K Elite Plus/T2 4K Pro Plus/T2 4K Express Plus). Images and illustrations in this manual are based on T2 4K Elite.
- The screenshots used as examples in this manual are those of the development stage, so they may vary from those in the final product.
- This manual is written for users who have a basic knowledge of how to use a computer. If there are no special instructions, perform the same operation as a normal computer operation.
- The contents of this product may modify without prior notice.

T2 4K Series User Manual

Version 3.2.1

Copyright © 2018-2020 Grass Valley. All rights reserved.

Contents

1 Notice	
MICROSOFT SOFTWARE LICENSE TERMS	
WINDOWS 10 IOT ENTERPRISE & MOBILE (ALL EDITIONS)	11
2 Overview	
Overview	24
About this manual	25
3 Part Names and Functions	
Front panel	26
Front panel	26
Indicators for redundant power supply (T2 4K Elite/T2 4K Elite Plus only)	27
Media card reader (T2 4K Elite/T2 4K Elite Plus only)	28
Control buttons	29
Rear panel	30
Rear panel	30
LTC/Monitor audio interface board	32
Video I/O board (Elite/Pro/Express)	32
Video I/O board (Elite Plus/Pro Plus/Express Plus)	32
Remote interface board	33
4 Connection/Start-up/Exit	
Connecting peripheral devices	34
Starting up and exiting T2	35
Starting up T2	35
Exiting T2 in the front panel mode	36
Exiting T2 in workstation mode	36
Switching front panel mode/workstation mode	37
Switching from the front panel mode to the workstation mode	37
Switching from the workstation mode to the front panel mode	37
Locking front panel	37
Switching IO mode	38
Assigning a channel for monitor output from the SDI terminal	39
Checking the model name and software version	40

5	Recording	
	Displaying Recorder channel in 1ch view	41
	Selecting Recorder channel in 3ch view	45
	Recording by VTR control (Recorder-VTR mode)	46
	Recording live video (Recorder-live mode).....	48
6	Import/Export	
	Importing a media file	50
	Displaying the [Browse] tab.....	50
	Displaying media file in removable media.....	52
	Playing media file in removable media.....	53
	Checking the properties of media file.....	54
	Changing media file list display	55
	Importing a media file	55
	Importing still images with serial numbers as a sequence clip	58
	Checking the transfer status	59
	Removing medium in removable media.....	60
	Removing removable media.....	61
	Importing a media file on WatchFolder.....	61
	Exporting a file	63
	Exporting contents to a file	63
	Exporting contents in T2 format	66
	Transferring a file to other T2	67
	Overview of file transfer function from T2 to T2	67
	Registering the FTP server connection settings	67
	Exporting a file from T2 to T2	68
	Uploading files to T2/downloading files from T2.....	69
	Loading and editing T2 contents to editing software.....	71
	Downloading and loading a recorded clip.....	71
	Downloading and loading a growing clip.....	72
	Directly loading a clip recorded or being recorded (T2 4K Elite/T2 4K Elite Plus only) ...	74
7	Contents Management	
	Managing contents in the bin	76
	Displaying the [Bin] tab.....	76
	Changing bin name.....	77
	Deleting a bin	78

Contents types and icons	78
Moving contents to another bin	79
Changing the display of contents list	80
Checking the properties of the contents.....	80
Releasing pairing of contents	82
Converting contents to other formats.....	82
Checking the recycle bin	84
Displaying the [Recycle Bin] tab	84
Backing up all data to other T2 (full sync backup).....	85
Overview of full sync backup function	85
Step 1: Setting T2 on the sync destination to the slave mode	85
Step 2: Setting T2 on the sync source to the master mode for data sync.....	86
8 Playing/Editing	
Displaying Player channel in 1ch view	88
Selecting Player channel in 3ch view	94
Loading contents to Player channel.....	97
Playing back video	97
Playing back with operation buttons.....	97
Playing back in variable speed mode (variable playback)	97
Playing back in jog/shuttle mode.....	98
Loading and playing back video currently recorded (chasing playback).....	99
Switching playback mode.....	100
Outputting currently recorded video with active through (E to E mode)	100
Loop playback of contents (Loop mode)	101
Sync playback of contents (Sync mode).....	101
Playback of contents with alpha channel (Fill/Key signal output mode)	103
Changing on-screen display indication	104
Showing on-screen display	104
Configuring display content of on-screen display	105
Editing a clip	107
Setting In and Out points to a clip	107
Trimming a clip between the set In-Out points	108
Creating a sub clip between In-Out points (highlight)	109
Cutting out a still image clip	109
Checking clip properties	110
Changing a clip name.....	110

Updating thumbnails of clips	110
Editing a playlist	110
Creating a playlist.....	110
Deleting an event from a playlist	112
Playing back a playlist	112
Icons for events.....	112
Trimming an event	113
Setting effects on an event	114
Updating playlist effect settings.....	116
Adding place holder to playlist.....	118
Replacing place holder on playlist	120
Changing a playlist name	120
Checking playlist properties	120
Checking event properties.....	120
Changing the playlist type	122
Setting marker.....	122
Showing marker list	123
Showing marker list of clip being recorded.....	124
Adding marker	125
Editing marker comment or timecode	126
Setting marker comment.....	127
Deleting marker	128
Moving to marker position.....	129
Entering characters and numerics.....	130
Entering characters	130
Entering timecode.....	131
Entering numerics.....	132

9 Operations in Workstation Mode

Screen elements	133
Keyboard and mouse operations in workstation mode.....	169
Multiple selection of contents	169
Loading contents to Player channel by drag & drop operation	170
Adding events to playlist by drag & drop operation	170
Sorting events in playlist by drag & drop operation.....	171
Replacing place holder by drag & drop operation	171
Major keyboard shortcuts.....	172
Changing keyboard shortcut assignment.....	172

Assigning commands to mouse operation	174
Recording sources at once (batch capturing)	176
Displaying media files in network drive	178
Searching for contents	179
Changing the playlist type	180
Editing playlist in the timeline format	182
Creating playlist in the timeline format	182
Adding event to playlist in the timeline format.....	183
Changing starting timecode of an event.....	184
Deleting event from playlist in the timeline format	184
Changing the display of playlist view	185
Changing the display of event list	185
Changing the display or background color of events.....	185
Checking logs of operations and processes	186
Displaying a log	186
Changing log level settings.....	187

10 Settings

Displaying the setting screen	188
General settings.....	189
General – Hardware settings.....	189
General – Network-1/Network-2 settings	194
General – Network-3 settings	196
General – FTP settings	197
General – Share Folder settings	199
General – Miscellaneous settings	202
Recorder settings	207
Recorder – Input Settings.....	207
Recorder – Timecode & Remote settings	209
Recorder – Capture settings.....	211
Player settings.....	213
Player – Video settings.....	213
Player – Timecode & Remote settings	216
Transfer settings	219
Transfer – common settings.....	219
Transfer – AVCHD settings.....	222

Transfer – AVI settings	223
Transfer – MXF settings	225
Transfer – XDCAM settings	226
Transfer – P2 settings	227
Transfer – QT settings	228
Transfer – Playlist settings	229
GPI settings	230
GPI – Input settings	230
GPI – Output settings	232
Other settings	233
Miscellaneous – Jog/Shuttle settings	233
Miscellaneous – AMP settings	234
Miscellaneous – Remote settings	235
11 Remote Control	
Remote control using AMP/BVW/TC Chase	236
Overview of AMP control	236
Overview of BVW control	237
Overview of TC Chase control	237
Controlling an external device from T2 with AMP/BVW (Recorder-VTR mode)	238
Controlling T2 from an external controller with AMP/BVW (Recorder-remote mode)...	238
Controlling T2 from an external controller with AMP/BVW (Player-remote mode)...	239
Controlling T2 with TC Chase (Player-remote mode)	240
Remote control using GPI	241
Overview of GPI control	241
Controlling external devices from T2 with GPI output	241
12 Utilizing ASIO audio device	
Using USB audio interface	243
Overview	243
Step 1: Installing the driver software on T2	243
Step 2: Configuring the ASIO audio device on T2	244
Using network audio (Dante Virtual Soundcard)	245
Overview	245
Step 1: Installing Dante Virtual Soundcard software	246
Step 2: Configuring Dante Virtual Soundcard on T2	246
Step 3: Configuring the ASIO audio device on T2	248
Step 4: Connecting T2 to the Dante network	249

13 Appendix

Keyboard shortcut list in workstation mode	250
Operation-ensured drivers for each device	256
Operation-ensured driver versions for XDCAM/XDCAM EX/XAVC/XAVC S	256
Operation-ensured driver version for P2	256
Operation-ensured products and versions for USB audio interface (ASIO audio) ..	256
Operation-ensured products and versions for network audio (ASIO audio)	256
Supported Formats	257
Supported formats of captured file (4K DCI/4K UHD)	257
Supported formats of captured file (HD/SD)	257
Supported formats of imported file (4K DCI/4K UHD)	257
Supported formats of imported file (HD/SD)	258
Format supported for conversion	259
Video input and video output formats	259
Notes on export and growing clip editing	260
Notes on record of external device and growing clip editing	261
Notes on FTP download and growing clip editing	261
Notes on Direct Access Folder and growing clip editing (T2 4K Elite/T2 4K Elite Plus only) ...	262
IO mode list	263
IO mode list - T2 4K Series (Elite/Pro/Express)	263
IO mode list - T2 4K Series (Elite Plus/Pro Plus/Express Plus)	264
AMP command list	265
Device management	265
Transport controls	266
Managing clips on the timeline	269
Managing stored clips	271
Clip data information	276
Flags	277
BVW command list	278
BVW list supporting remote mode	279
RS422 input/output pin	280
GPIO input/output pin	280

Notice

MICROSOFT SOFTWARE LICENSE TERMS WINDOWS 10 IOT ENTERPRISE & MOBILE (ALL EDITIONS)

Last updated July 2016

IF YOU LIVE IN (OR IF YOUR PRINCIPAL PLACE OF BUSINESS IS IN) THE UNITED STATES, PLEASE READ THE BINDING ARBITRATION CLAUSE AND CLASS ACTION WAIVER IN SECTION 9. IT AFFECTS HOW DISPUTES ARE RESOLVED.

Thank you for choosing Microsoft!

Depending on how you obtained the Windows software, this is a license agreement between (i) you and the device manufacturer or software installer that distributes the software with your device; or (ii) you and Microsoft Corporation (or, based on where you live or if a business where your principal place of business is located, one of its affiliates) if you acquired the software from a retailer. Microsoft is the device manufacturer for devices produced by Microsoft or one of its affiliates, and Microsoft is the retailer if you acquired the software directly from Microsoft.

This agreement describes your rights and the conditions upon which you may use the Windows software. You should review the entire agreement, including any supplemental license terms that accompany the software and any linked terms, because all of the terms are important and together create this agreement that applies to you. You can review linked terms by pasting the (aka.ms/) link into a browser window.

By accepting this agreement or using the software, you agree to all of these terms, and consent to the transmission of certain information during activation and during your use of the software as per the privacy statement described in Section 3. If you do not accept and comply with these terms, you may not use the software or its features. You may contact the device manufacturer or installer, or your retailer if you purchased the software directly, to determine its return policy and return the software or device for a refund or credit under that policy. You must comply with that policy, which might require you to return the software with the entire device on which the software is installed for a refund or credit, if any.

1. Overview.

- a. Applicability.** This agreement applies to the Windows software that is preinstalled on your device, or acquired from a retailer and installed by you, the media on which you received the software (if any), any fonts, icons, images or sound files included with the software, and also any Microsoft updates, upgrades, supplements or services for the software, unless other terms come with them. It also applies to Windows apps developed by Microsoft that provide functionality such as mail, calendar, contacts, music and news that are included with and are a part of Windows. If this agreement contains terms regarding a feature or service not available on your device, then those terms do not apply.
- b. Additional terms.** Depending on your device's capabilities, how it is configured, and how you use it, additional Microsoft and third party terms may apply to your use of certain features, services and apps.
- (i) Some Windows apps provide an access point to, or rely on, online services, and the use of those services is sometimes governed by separate terms and privacy policies, such as the Microsoft Services Agreement at (aka.ms/msa). You can view these terms and policies by looking at the service terms of use or the app's settings, as applicable; please read them. The services may not be available in all regions.
 - (ii) The manufacturer or installer may also preinstall apps, which will be subject to separate license terms.
 - (iii) The software may include third party software such as Adobe Flash Player that is licensed under its own terms. You agree that your use of Adobe Flash Player is governed by the license terms for Adobe Systems Incorporated at (aka.ms/adobeflash). Adobe and Flash are either registered trademarks or trademarks of Adobe Systems Incorporated in the United States and/or other countries.
 - (iv) The software may include third party programs that are licensed to you under this agreement, or under their own terms. License terms, notices and acknowledgements, if any, for the third party program can be view at (aka.ms/thirdpartynotices).

2. Installation and Use Rights.

- a. License.** The software license is permanently assigned to the device with which you acquired the software. You may only use the software on that device.
- b. Device.** In this agreement, "device" means a physical hardware system)

with an internal storage device capable of running the software. A hardware partition or blade is considered to be a device.

c. Restrictions. The manufacturer or installer and Microsoft reserve all rights (such as rights under intellectual property laws) not expressly granted in this agreement. For example, this license does not give you any right to, and you may not:

- (i) use or virtualize features of the software separately;
- (ii) publish, copy (other than the permitted backup copy), rent, lease, or lend the software;
- (iii) transfer the software (except as permitted by this agreement);
- (iv) work around any technical restrictions or limitations in the software;
- (v) use the software as server software, for commercial hosting, make the software available for simultaneous use by multiple users over a network, install the software on a server and allow users to access it remotely, or install the software on a device for use only by remote users;
- (vi) reverse engineer, decompile, or disassemble the software, or attempt to do so, except and only to the extent that the foregoing restriction is (a) permitted by applicable law; (b) permitted by licensing terms governing the use of open source components that may be included with the software; or (c) required to debug changes to any libraries licensed under the GNU Lesser General Public License which are included with and linked to by the software; and
- (vii) when using Internet-based features you may not use those features in any way that could interfere with anyone else's use of them, or to try to gain access to or use any service, data, account, or network, in an unauthorized manner.

d. Multi use scenarios.

- (i) **Multiple versions.** If when acquiring the software, you were provided with multiple versions (such as 32-bit and 64-bit versions), you may install and activate only one of those versions at a time.
- (ii) **Multiple or pooled connections.** Hardware or software you use to multiplex or pool connections, or reduce the number of devices or users that access or use the software, does not reduce the number of licenses you need. You may only use such hardware or software if you have a license for each instance of the software you are using.
- (iii) **Device connections.** You may allow up to 20 other devices to access the software installed on the licensed device for the purpose

of using the following software features: file services, print services, Internet information services, and Internet connection sharing and telephony services on the licensed device. The 20 connection limit applies to devices that access the software indirectly through “multiplexing” or other software or hardware that pools connections. You may allow any number of devices to access the software on the licensed device to synchronize data between devices. This section does not mean, however, that you have the right to install the software, or use the primary function of the software (other than the features listed in this section), on any of these other devices.

- (iv) **Remote access.** Users may access the licensed device from another device using remote access technologies, but only on devices separately licensed to run the same or higher edition of this software.
- (v) **Remote assistance.** You may use remote assistance technologies to share an active session without obtaining any additional licenses for the software. Remote assistance allows one user to connect directly to another user’s computer, usually to correct problems.
- (vi) **POS application.** If the software is installed on a retail point of service device, you may use the software with a point of service application (“POS Application”). A POS Application is a software application which provides only the following functions: (i) process sales and service transactions, scan and track inventory, record and/or transmit customer information, and perform related management functions, and/or (ii) provide information directly and indirectly to customers about available products and services. You may use other programs with the software as long as the other programs: (i) directly support the manufacturer’s specific use for the device, or (ii) provide system utilities, resource management, or anti-virus or similar protection. For clarification purposes, an automated teller machine (“ATM”) is not a retail point of service device.
- (vii) **Cloud Computing Devices.** If your device uses Internet browsing functionality to connect to and access cloud hosted applications: (i) no desktop functions may run locally on the device, and (ii) any files that result from the use of the desktop functions may not be permanently stored on the system. “Desktop functions,” as used in this agreement, means a consumer or business task or process performed by a computer or computing device. This includes but is not limited to email, word processing, spreadsheets, database, scheduling, network or internet browsing and personal finance.
- (viii) **Desktop Functions.** If your system performs desktop functions,

then you must ensure that they: (i) are only used to support the application, and (ii) operate only when used with the application.

e. Specific Use. The manufacturer designed the licensed device for a specific use. You may only use the software for that use.

f. Backup copy. You may make a single copy of the software for backup purposes, and may also use that backup copy to transfer the software if it was acquired as stand-alone software, as described below.

3. Privacy; Consent to Use of Data. Your privacy is important to us. Some of the software features send or receive information when using those features. Many of these features can be switched off in the user interface, or you can choose not to use them. By accepting this agreement and using the software you agree that Microsoft may collect, use, and disclose the information as described in the Microsoft Privacy Statement available at (aka.ms/privacy), and as may be described in the user interface associated with the software features.

4. Transfer

a. Software preinstalled on device. If you acquired the software preinstalled on a device, you may transfer the license to use the software directly to another user, only with the licensed device. The transfer must include the software and, if provided with the device, an authentic Windows label including the product key. Before any permitted transfer, the other party must agree that this agreement applies to the transfer and use of the software.

b. Stand-alone software. If you acquired the software as stand-alone software, you may transfer the software to another device that belongs to you. You may also transfer the software to a device owned by someone else if (i) you are the first licensed user of the software and (ii) the new user agrees to the terms of this agreement. You may use the backup copy we allow you to make or the media that the software came on to transfer the software. Every time you transfer the software to a new device, you must remove the software from the prior device. You may not transfer the software to share licenses between devices.

5. Authorized Software and Activation. You are authorized to use this software only if you are properly licensed and the software has been properly activated with a genuine product key or by other authorized method. When you connect to the Internet while using the software, the software will automatically contact Microsoft or its affiliate to confirm the software is genuine and the license is associated with the licensed device. You can also activate the software manually by Internet or telephone. In either case, transmission

of certain information will occur, and Internet, telephone and SMS service charges may apply. During activation (or reactivation that may be triggered by changes to your device's components), the software may determine that the installed instance of the software is counterfeit, improperly licensed or includes unauthorized changes. If activation fails the software will attempt to repair itself by replacing any tampered Microsoft software with genuine Microsoft software. You may also receive reminders to obtain a proper license for the software. Successful activation does not confirm that the software is genuine or properly licensed. You may not bypass or circumvent activation. To help determine if your software is genuine and whether you are properly licensed, see (aka.ms/genuine). Certain updates, support, and other services might only be offered to users of genuine Microsoft software.

- 6. Updates.** You may obtain updates only from Microsoft or authorized sources, and Microsoft may need to update your system to provide you with those updates. The software periodically checks for system and app updates, and may download and install them for you. To the extent automatic updates are enabled on your device, by accepting this agreement, you agree to receive these types of automatic updates without any additional notice.
- 7. Geographic and Export Restrictions.** If your software is restricted for use in a particular geographic region, then you may activate the software only in that region. You must also comply with all domestic and international export laws and regulations that apply to the software, which include restrictions on destinations, end users, and end use. For further information on geographic and export restrictions, visit (aka.ms/georestrict) and (aka.ms/exporting).
- 8. Support and Refund Procedures.** For the software generally, contact the device manufacturer or installer for support options. Refer to the support number provided with the software. For updates and supplements obtained directly from Microsoft, Microsoft may provide limited support services for properly licensed software as described at (aka.ms/mssupport). If you are seeking a refund, contact the manufacturer or installer to determine its refund policies. You must comply with those policies, which might require you to return the software with the entire device on which the software is installed for a refund.
- 9. Binding Arbitration and Class Action Waiver if You Live in (or if a Business Your Principal Place of Business is in) the United States.**

We hope we never have a dispute, but if we do, you and we agree to try for 60 days to resolve it informally. If we can't, you and we agree to **binding individual arbitration before the American Arbitration Association**

(“AAA”) under the Federal Arbitration Act (“FAA”), and not to sue in court in front of a judge or jury. Instead, a neutral arbitrator will decide and the arbitrator’s decision will be final except for a limited right of appeal under the FAA. **Class action lawsuits, class-wide arbitrations, private attorney-general actions, and any other proceeding where someone acts in a representative capacity aren’t allowed. Nor is combining individual proceedings without the consent of all parties.** “We,” “our,” and “us” includes Microsoft, the device manufacturer, and software installer.

- a. Disputes covered—everything except IP.** The term “dispute” is as broad as it can be. It includes any claim or controversy between you and the manufacturer or installer, or you and Microsoft, concerning the software, its price, or this agreement, under any legal theory including contract, warranty, tort, statute, or regulation, **except disputes relating to the enforcement or validity of your, your licensors’, our, or our licensors’ intellectual property rights.**
- b. Mail a Notice of Dispute first.** If you have a dispute and our customer service representatives can’t resolve it, send a Notice of Dispute by U.S. Mail to the manufacturer or installer, ATTN: LEGAL DEPARTMENT. If your dispute is with Microsoft, mail it to Microsoft Corporation, ATTN: LCA ARBITRATION, One Microsoft Way, Redmond, WA 98052-6399. Tell us your name, address, how to contact you, what the problem is, and what you want. A form is available at (aka.ms/disputeform). We’ll do the same if we have a dispute with you. After 60 days, you or we may start an arbitration if the dispute is unresolved.
- c. Small claims court option.** Instead of mailing a Notice of Dispute, and if you meet the court’s requirements, you may sue us in small claims court in your county of residence (or if a business your principal place of business) or our principal place of business—King County, Washington USA if your dispute is with Microsoft. We hope you’ll mail a Notice of Dispute and give us 60 days to try to work it out, but you don’t have to before going to small claims court.
- d. Arbitration procedure.** The AAA will conduct any arbitration under its Commercial Arbitration Rules (or if you are an individual and use the software for personal or household use, or if the value of the dispute is \$75,000 USD or less whether or not you are an individual or how you use the software, its Consumer Arbitration Rules). For more information, see (aka.ms/adr) or call 1-800-778-7879. To start an arbitration, submit the form available at (aka.ms/arbitration) to the AAA; mail a copy to the manufacturer or installer (or to Microsoft if your dispute is with Microsoft). In a dispute involving \$25,000 USD or less, any hearing will be telephonic unless the arbitrator finds good cause to hold an in-person

hearing instead. Any in-person hearing will take place in your county of residence (of if a business your principal place of business) or our principal place of business—King County, Washington if your dispute is with Microsoft. You choose. The arbitrator may award the same damages to you individually as a court could. The arbitrator may award declaratory or injunctive relief only to you individually to satisfy your individual claim.

e. Arbitration fees and payments.

- (i) **Disputes involving \$75,000 USD or less.** The manufacturer or installer (or Microsoft if your dispute is with Microsoft) will promptly reimburse your filing fees and pay the AAA's and arbitrator's fees and expenses. If you reject our last written settlement offer made before the arbitrator was appointed, your dispute goes all the way to an arbitrator's decision (called an "award"), and the arbitrator awards you more than this last written offer, the manufacturer or installer (or Microsoft if your dispute is with Microsoft) will: (1) pay the greater of the award or \$1,000 USD; (2) pay your reasonable attorney's fees, if any; and (3) reimburse any expenses (including expert witness fees and costs) that your attorney reasonably accrues for investigating, preparing, and pursuing your claim in arbitration. The arbitrator will determine the amounts unless you and we agree on them.
- (ii) **Disputes involving more than \$75,000 USD.** The AAA rules will govern payment of filing fees and the AAA's and arbitrator's fees and expenses.
- (iii) **Disputes involving any amount.** If you start an arbitration we won't seek our AAA or arbitrator's fees and expenses, or your filing fees we reimbursed, unless the arbitrator finds the arbitration frivolous or brought for an improper purpose. If we start an arbitration we will pay all filing, AAA, and arbitrator's fees and expenses. We won't seek our attorney's fees or expenses from you in any arbitration. Fees and expenses are not counted in determining how much a dispute involves.

f. Must file within one year. You and we must file in small claims court or arbitration any claim or dispute (except intellectual property disputes — see Section 9.a.) within one year from when it first could be filed. Otherwise, it's permanently barred.

g. Severability. If the class action waiver is found to be illegal or unenforceable as to all or some parts of a dispute, those parts won't be arbitrated but will proceed in court, with the rest proceeding in

arbitration. If any other provision of Section 9 is found to be illegal or unenforceable, that provision will be severed but the rest of Section 9 still applies.

h. Conflict with AAA rules. This agreement governs if it conflicts with the AAA's Commercial Arbitration Rules or Consumer Arbitration Rules.

i. Microsoft as party or third-party beneficiary. If Microsoft is the device manufacturer or if you acquired the software from a retailer, Microsoft is a party to this agreement. Otherwise, Microsoft is not a party but is a third-party beneficiary of your agreement with the manufacturer or installer to resolve disputes through informal negotiation and arbitration.

10. Governing Law. The laws of the state or country where you live (or if a business where your principal place of business is located) govern all claims and disputes concerning the software, its price, or this agreement, including breach of contract claims and claims under state consumer protection laws, unfair competition laws, implied warranty laws, for unjust enrichment, and in tort, regardless of conflict of law principles. In the United States, the FAA governs all provisions relating to arbitration.

11. Consumer Rights, Regional Variations. This agreement describes certain legal rights. You may have other rights, including consumer rights, under the laws of your state or country. You may also have rights with respect to the party from which you acquired the software. This agreement does not change those other rights if the laws of your state or country do not permit it to do so. For example, if you acquired the software in one of the below regions, or mandatory country law applies, then the following provisions apply to you:

a. Australia. References to "Limited Warranty" are references to the express warranty provided by Microsoft or the manufacturer or installer. This warranty is given in addition to other rights and remedies you may have under law, including your rights and remedies in accordance with the statutory guarantees under the Australian Consumer Law.

In this section, "goods" refers to the software for which Microsoft or the manufacturer or installer provides the express warranty. Our goods come with guarantees that cannot be excluded under the Australian Consumer Law. You are entitled to a replacement or refund for a major failure and compensation for any other reasonably foreseeable loss or damage. You are also entitled to have the goods repaired or replaced if the goods fail to be of acceptable quality and the failure does not amount to a major failure.

b. Canada. You may stop receiving updates on your device by turning off Internet access. If and when you re-connect to the Internet, the software

will resume checking for and installing updates.

c. European Union. The academic use restriction in Section 12.d(i) below does not apply in the jurisdictions listed on this site: ([aka.ms/academicuse](#)).

d. Germany and Austria.

(i) **Warranty.** The properly licensed software will perform substantially as described in any Microsoft materials that accompany the software. However, the manufacturer or installer, and Microsoft, give no contractual guarantee in relation to the licensed software.

(ii) **Limitation of Liability.** In case of intentional conduct, gross negligence, claims based on the Product Liability Act, as well as, in case of death or personal or physical injury, the manufacturer or installer, or Microsoft is liable according to the statutory law.

Subject to the preceding sentence, the manufacturer or installer, or Microsoft will only be liable for slight negligence if the manufacturer or installer or Microsoft is in breach of such material contractual obligations, the fulfillment of which facilitate the due performance of this agreement, the breach of which would endanger the purpose of this agreement and the compliance with which a party may constantly trust in (so-called "cardinal obligations"). In other cases of slight negligence, the manufacturer or installer or Microsoft will not be liable for slight negligence.

e. Other regions. See ([aka.ms/variations](#)) for a current list of regional variations

12. Additional Notices.

a. Networks, data and Internet usage. Some features of the software and services accessed through the software may require your device to access the Internet. Your access and usage (including charges) may be subject to the terms of your cellular or internet provider agreement. Certain features of the software may help you access the Internet more efficiently, but the software's usage calculations may be different from your service provider's measurements. You are always responsible for (i) understanding and complying with the terms of your own plans and agreements, and (ii) any issues arising from using or accessing networks, including public/open networks. You may use the software to connect to networks, and to share access information about those networks, only if you have permission to do so.

b. H.264/AVC and MPEG-4 visual standards and VC-1 video standards. The software may include H.264/MPEG-4 AVC and/or VC-1 decoding

technology. MPEG LA, L.L.C. requires this notice:

THIS PRODUCT IS LICENSED UNDER THE AVC, THE VC-1, AND THE MPEG-4 PART 2 VISUAL PATENT PORTFOLIO LICENSES FOR THE PERSONAL AND NON-COMMERCIAL USE OF A CONSUMER TO (i) ENCODE VIDEO IN COMPLIANCE WITH THE ABOVE STANDARDS (“VIDEO STANDARDS”) AND/OR (ii) DECODE AVC, VC-1, AND MPEG-4 PART 2 VIDEO THAT WAS ENCODED BY A CONSUMER ENGAGED IN A PERSONAL AND NON-COMMERCIAL ACTIVITY AND/OR WAS OBTAINED FROM A VIDEO PROVIDER LICENSED TO PROVIDE SUCH VIDEO. NO LICENSE IS GRANTED OR SHALL BE IMPLIED FOR ANY OTHER USE. ADDITIONAL INFORMATION MAY BE OBTAINED FROM MPEG LA, L.L.C. SEE WWW.MPEGLA.COM

- c. Malware protection.** Microsoft cares about protecting your device from malware. The software will turn on malware protection if other protection is not installed or has expired. To do so, other antimalware software will be disabled or may have to be removed.
- d. Limited rights versions.** If the software version you acquired is marked or otherwise intended for a specific or limited use, then you may only use it as specified. You may use other programs with the software as long as the other programs directly support the manufacturer’s specific use for the device, or provide system utilities, resource management, or anti-virus or similar protection.
 - (i) **Academic.** For academic use, you must be a student, faculty or staff of an educational institution at the time of purchase.
 - (ii) **Evaluation.** For evaluation (or test or demonstration) use, you may not sell the software, use it in a live operating environment, or use it after the evaluation period. Notwithstanding anything to the contrary in this Agreement, evaluation software is provided “AS IS”.
 - (iii) **NFR.** You may not sell software marked as “NFR” or “Not for Resale”.

13. Entire Agreement. This agreement (together with the printed paper license terms or other terms accompanying any software supplements, updates, and services that are provided by the manufacturer or installer, or Microsoft, and that you use), and the terms contained in web links listed in this agreement, are the entire agreement for the software and any such supplements, updates, and services (unless the manufacturer or installer, or Microsoft, provides other terms with such supplements, updates, or services). You can review this agreement after your software is running by going to (aka.ms/useterms) or going to Settings - System - About within the software. You can also review

the terms at any of the links in this agreement by typing the URLs into a browser address bar, and you agree to do so. You agree that you will read the terms before using the software or services, including any linked terms. You understand that by using the software and services, you ratify this agreement and the linked terms. There are also informational links in this agreement. The links containing notices and binding terms are:

- [Windows 10 Privacy Statement \(aka.ms/privacy\)](https://aka.ms/privacy)
- [Microsoft Services Agreement \(aka.ms/msa\)](https://aka.ms/msa)
- [Adobe Flash Player License Terms \(aka.ms/adobe-flash\)](https://aka.ms/adobe-flash)

NO WARRANTY

THE SOFTWARE ON YOUR DEVICE (INCLUDING THE APPS) IS LICENSED “AS IS.” TO THE MAXIMUM EXTENT PERMITTED BY YOUR LOCAL LAWS, YOU BEAR THE ENTIRE RISK AS TO THE SOFTWARE’S QUALITY AND PERFORMANCE. SHOULD IT PROVE DEFECTIVE, YOU ASSUME THE ENTIRE COST OF ALL SERVICING OR REPAIR. NEITHER THE DEVICE MANUFACTURER NOR MICROSOFT GIVES ANY EXPRESS WARRANTIES, GUARANTEES, OR CONDITIONS FOR THE SOFTWARE. TO THE EXTENT PERMITTED UNDER YOUR LOCAL LAWS, THE MANUFACTURER AND MICROSOFT EXCLUDE ALL IMPLIED WARRANTIES AND CONDITIONS, INCLUDING THOSE OF MERCHANTABILITY, QUALITY, FITNESS FOR A PARTICULAR PURPOSE, AND NON-INFRINGEMENT. YOU MAY HAVE ADDITIONAL CONSUMER RIGHTS OR STATUTORY GUARANTEES UNDER LOCAL LAWS THAT THESE TERMS CANNOT CHANGE.

IF YOUR LOCAL LAWS IMPOSE A WARRANTY, GUARANTEE, OR CONDITION EVEN THOUGH THIS AGREEMENT DOES NOT, ITS TERM IS LIMITED TO 90 DAYS FROM WHEN THE FIRST USER ACQUIRES THE SOFTWARE. IF THE MANUFACTURER OR MICROSOFT BREACHES SUCH A WARRANTY, GUARANTEE, OR CONDITION, YOUR SOLE REMEDY, AT THE MANUFACTURER’S OR MICROSOFT’S ELECTION, IS (I) REPAIR OR REPLACEMENT OF THE SOFTWARE AT NO CHARGE, OR (II) RETURN OF THE SOFTWARE (OR AT ITS ELECTION THE DEVICE ON WHICH THE SOFTWARE WAS INSTALLED) FOR A REFUND OF THE AMOUNT PAID, IF ANY. THESE ARE YOUR ONLY REMEDIES FOR BREACH OF A WARRANTY, GUARANTEE, OR CONDITION YOUR LOCAL LAWS IMPOSE.

TO THE EXTENT NOT PROHIBITED BY YOUR LOCAL LAWS, IF YOU HAVE ANY BASIS FOR RECOVERING DAMAGES, YOU CAN RECOVER FROM THE MANUFACTURER OR MICROSOFT ONLY DIRECT DAMAGES UP TO THE AMOUNT YOU PAID FOR THE SOFTWARE (OR UP TO \$50 USD IF YOU ACQUIRED THE SOFTWARE FOR NO CHARGE). YOU WILL NOT, AND WAIVE ANY RIGHT TO, SEEK TO RECOVER ANY OTHER DAMAGES OR REMEDY, INCLUDING LOST PROFITS AND DIRECT, CONSEQUENTIAL,

SPECIAL, INDIRECT, OR INCIDENTAL DAMAGES, UNDER ANY PART OF THIS AGREEMENT OR UNDER ANY THEORY. THIS LIMITATION APPLIES TO (I) ANYTHING RELATED TO THIS AGREEMENT, THE SOFTWARE (INCLUDING THE APPS), THE DEVICE, SERVICES, CORRUPTION OR LOSS OF DATA, FAILURE TO TRANSMIT OR RECEIVE DATA, CONTENT (INCLUDING CODE) ON THIRD PARTY INTERNET SITES OR THIRD PARTY PROGRAMS, AND (II) CLAIMS FOR BREACH OF CONTRACT, WARRANTY, GUARANTEE, OR CONDITION; STRICT LIABILITY, NEGLIGENCE, OR OTHER TORT; VIOLATION OF A STATUTE OR REGULATION; UNJUST ENRICHMENT; OR UNDER ANY OTHER THEORY.

THE DAMAGE EXCLUSIONS AND REMEDY LIMITATIONS IN THIS AGREEMENT APPLY EVEN IF YOU HAVE NO REMEDY (THE SOFTWARE IS LICENSED "AS IS"), IF REPAIR, REPLACEMENT, OR A REFUND (IF REQUIRED BY YOUR LOCAL LAW) DOES NOT FULLY COMPENSATE YOU FOR ANY LOSSES, IF THE MANUFACTURER OR MICROSOFT KNEW OR SHOULD HAVE KNOWN ABOUT THE POSSIBILITY OF THE DAMAGES, OR IF THE REMEDY FAILS OF ITS ESSENTIAL PURPOSE.

Check with your device manufacturer to determine if your device is covered by a warranty.

Overview

Overview

T2 is multi-channel video disk recorder with IO modes such as “4K 1 input”, “4K 1 output”, and “HD/SD 1 input/2 output”, which allows simultaneous video recording and playing.

Video and audio data are saved in the built-in data drive.

T2 has pre-installed software that performs recording/editing/playing of video and creating or playing of playlists. The following two operation modes are available depending on the environment.

➤ Front panel mode

You can operate this mode by tapping the display on the touch screen LCD on the T2 front panel. The operation is available under minimum network environment.

The basic operations can be performed only on the front panel mode.

➤ Workstation mode

You can connect and use a PC monitor, mouse, and keyboard to T2 in this mode.

All functions are available in this mode.

Operations in Workstation Mode ▶ P133

The operating instructions on this manual mainly describe procedures in the front panel mode and [[HD/SD] 1 in 2 out] mode.

TIP

- The model name of your T2 can be confirmed by version information.

Checking the model name and software version ▶ P40

- For IO modes available on your T2, see the IO mode list.
IO mode list ▶ P263

NOTE

- The actual screen display or operation procedure may differ from that described in this manual, depending on the T2 model you use or the IO mode to be set.

About this manual

The indications and the meanings are as follows.

Section 6 — Import/Export

Displaying media file in removable media

Media files in a removable media such as USB removable device, XDCAM, P2, etc. can be displayed without importing to T2.

(1) **NOTE**

- When using XDCAM, XDCAM EX, XAVC, XAVC S, or P2 device, install the driver in the maintenance mode before connecting the device to T2. For more information about the maintenance mode, refer to the T2 Service Manual.
Operation-ensured driver versions for XDCAM/XDCAM EX/XAVC/XAVC S ▶ P256
Operation-ensured driver version for P2 ▶ P256

(2) **TIP**

- For details on the supported formats, see "Appendix".
Supported Formats ▶ P257
- If you make settings of the network drive in the workstation mode, you can display media files in the network drive from the [Browse] tab.
Displaying media files in network drive ▶ P178

(3)

1 Connect a removable media to your T2 and insert medium.

For T2 4K Elite/T2 4K Elite Plus, cards can be directly inserted into the slots of the media card reader. When the media is recognized by T2, the indicator on the left of the card slot lights up in green.
Media card reader (T2 4K Elite/T2 4K Elite Plus only) ▶ P28

2 Tap [Import].



The screen switches to the [Browse] tab.

NOTE

- If it does not switch to the [Browse] tab, switch manually.

3 Tap [New connection] and select a medium type.



52 T2 User Manual January 1, 2020

* The illustration on this page is only for explanation purpose. It differs from the actual page on this manual.

(1)	NOTE	Describes cautions and restrictions for operations.
(2)	TIP	Describes important points for operations.
(3)	Reference page	Indicates related pages.

Part Names and Functions

Front panel

Front panel

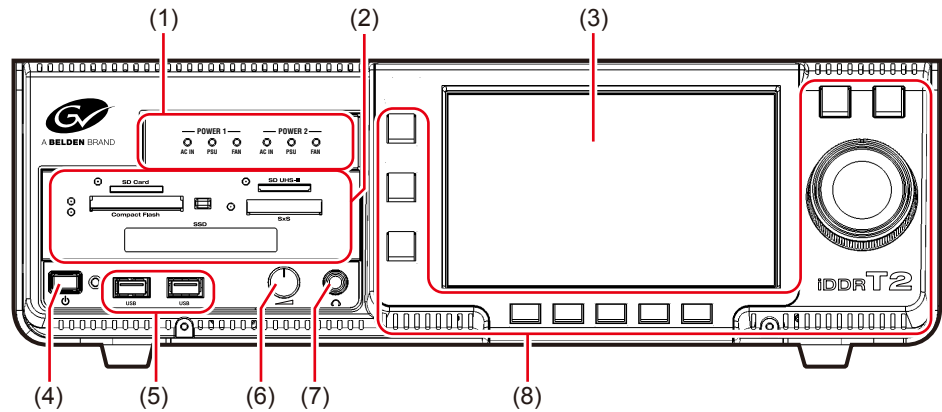

* This illustration is an example of T2 4K Elite.

(1)	Indicators for redundant power supply	Indicates the status of the redundant power supply. Indicators for redundant power supply (T2 4K Elite/T2 4K Elite Plus only) ► P27
(2)	Media card reader	Various types of media cards can be inserted. Media card reader (T2 4K Elite/T2 4K Elite Plus only) ► P28
(3)	Touch screen LCD	Operates T2 by tapping the display on the screen.
(4)	Power switch	Turns on T2.
(5)	USB 3.0 ports	Used to connect USB 3.0 removable devices.
(6)	Volume control	Used to adjust the headphone volume.

(7)	Headphone jack	Used to connect a headphone. Audio level detail display (Recorder channel) ▶ P147 Audio level detail display (Player channel) ▶ P160
(8)	Control buttons	Performs channel selection or playing back and recording of video. Control buttons ▶ P29

Indicators for redundant power supply (T2 4K Elite/T2 4K Elite Plus only)

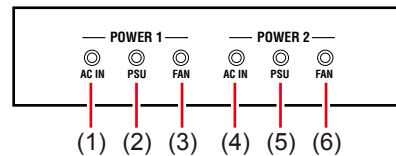

(1)	AC IN (Power failure detection indicator)	The indicator lights in green when the main power of the power unit 1 is turned on. If it blinks in red, the power cable may be disconnected or a power failure has occurred.
(2)	PSU (Power unit malfunction indicator)	The indicator lights in green when the main power of the power unit 1 is turned on. If it blinks in red, the power unit may be malfunctioning or may be attached incorrectly. When the power failure indicator lights in green and the power unit malfunction indicator blinks in red, contact the support.
(3)	FAN (FAN abnormality detection indicator)	The indicator lights in green when the main power of the power unit 1 is turned on. If it blinks in red, the fan may be malfunctioning.
(4)	AC IN (Power failure detection indicator)	The indicator lights in green when the main power of the power unit 2 is turned on. If it blinks in red, the power cable may be disconnected or a power failure has occurred.

(5)	PSU (Power unit malfunction indicator)	The indicator lights in green when the main power of the power unit 2 is turned on. If it blinks in red, the power unit may be malfunctioning or may be attached incorrectly. When the power failure indicator lights in green and the power unit malfunction indicator blinks in red, contact the support.
(6)	FAN (FAN abnormality detection indicator)	The indicator lights in green when the main power of the power unit 2 is turned on. If it blinks in red, the fan may be malfunctioning.

Media card reader (T2 4K Elite/T2 4K Elite Plus only)

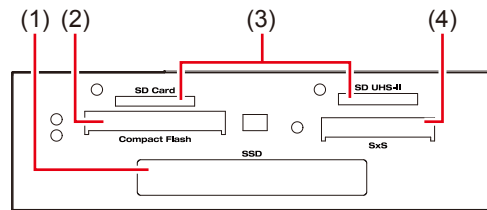

(1)	Exclusive SSD drive slot	Used to read and write data in an inserted SSD.
(2)	Compact Flash card slot	Used to read and write data in an inserted Compact Flash card.
(3)	SD card slots	Used to read and write data in an inserted SD card. Only the SD card slot on the right supports UHS-II/microP2.
(4)	SxS memory card slot	Used to read and write data in an inserted SxS memory card. * Any card other than SxS memory card such as an ExpressCard will not operate.

NOTE • While any of the indicators for media cards blinks in green, data is being read or written. Do not insert or remove a media card.

Control buttons

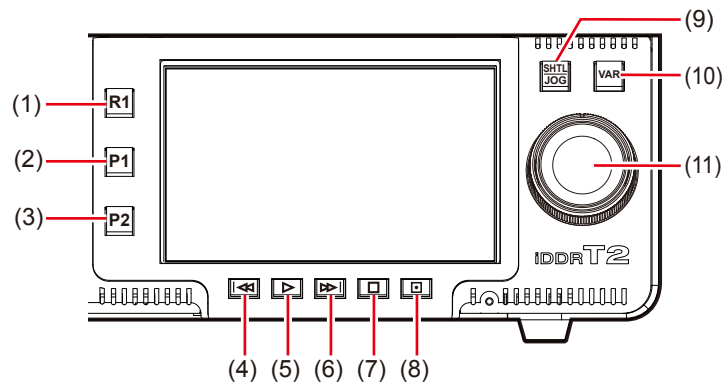

(1)	[R1] button	Switches to 1ch view of the R1 channel. Makes the R1 channel active.
(2)	[P1] button	Switches to the 1ch view of P1 channel. Makes the P1 channel active.
(3)	[P2] button	Switches to the 1ch view of P2 channel. Makes the P2 channel active.
(4)	[Rew] button	By every press, moves back frame by frame. Holding on the button will rewind by 32 times speed.
(5)	[Play] button	Starts playback.
(6)	[FF] button	By every press, moves forward frame by frame. Holding on the button will fast-forward by 32 times speed.
(7)	[Stop] button	Stops playback or recording.
(8)	[Rec] button	Starts recording.
(9)	[SHTL/JOG] button	Switches to the jog/shuttle mode. Playing back in jog/shuttle mode ► P98
(10)	[VAR] button	Switches to the variable speed mode. Displays the speed controller and allows to change the playback speed. Playing back in variable speed mode (variable playback) ► P97
(11)	Jog/Shuttle	When the [SHTL/JOG] button is on, executes jog/shuttle playback operations. When the [VAR] button is on, executes variable speed playback.

NOTE • When [[HD/SD] 0 in 3 out] is selected, the [R1], [P1], and [P2] buttons control P1, P2, and P3 channels respectively.

<p>[Rew] + [Stop] buttons</p>	<p>While playing a clip, moves to the previous In/Out point or to the top of the clip.</p> <p>While playing a playlist, moves to the previous event.</p> <p>It allows to include the position of the previous marker as a moving destination. In the [Marker] dialog box, check [Show marker icons on the scrub bar], click [When moving to edit point :] list and select [Cue up on Markers].</p> <p>[Marker] dialog box►P124</p>
<p>[FF] + [Stop] buttons</p>	<p>While playing a clip, moves to the next In/Out point or to the end of the clip.</p> <p>While playing a playlist, moves to the next event.</p> <p>It allows to include the position of the next marker as a moving destination. In the [Marker] dialog box, check [Show marker icons on the scrub bar], click [When moving to edit point :] list and select [Cue up on Markers].</p> <p>[Marker] dialog box►P124</p>

Rear panel

Rear panel

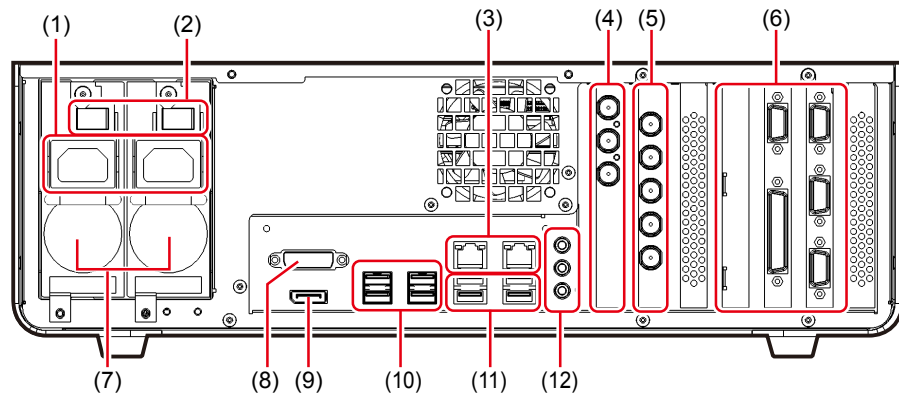

<p>(1)</p>	<p>AC Power inlet (3-pin)</p>	<p>Used to connect to the AC power outlet with the supplied power cable.</p>
<p>(2)</p>	<p>Main power switch</p>	<p>Turns on/off the main power.</p>
<p>(3)</p>	<p>LAN port</p>	<p>Used to connect a LAN cable.</p>

(4)	LTC/Monitor audio interface board	Used for LTC (timecode) input/output and audio monitor. LTC/Monitor audio interface board ► P32
(5)	Video I/O board	Used for input to the Recorder channel and output from the Player channel. Video I/O board (Elite/Pro/Express) ► P32 Video I/O board (Elite Plus/Pro Plus/Express Plus) ► P32
(6)	Remote interface board	Used for remote control of Recorder channel or Player channel. Remote interface board ► P33
(7)	Power unit 2 (left) (T2 4K Elite/T2 4K Elite Plus only), Power unit 1 (right)	T2 4K Elite/T2 4K Elite Plus has redundant power supply composed of power unit 1 and power unit 2. Other T2 4K Series products have single power supply of the power unit 1.
(8)	Monitor (DVI-D) port	Used to connect a PC monitor. An analog monitor can not be used.
(9)	Monitor (DisplayPort) port	Used to connect a PC monitor.
(10)	USB 2.0 port	Used to connect a keyboard, mouse, and so on.
(11)	USB 3.0 port	Used to connect USB 3.0 removable devices.
(12)	Sound	Not used.

NOTE

- In the workstation mode, you cannot use T2 with the monitor ports (DVI-D/DisplayPort) connected simultaneously. (Exclusive use only)
- Be sure to turn off your T2 before connecting/disconnecting the cable to/from the monitor port or turning on/off the display.

LTC/Monitor audio interface board

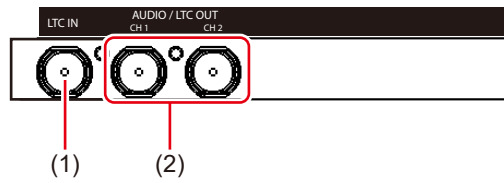

(1)	LTC IN	Used for LTC (timecode) input.
(2)	AUDIO / LTC OUT (CH1/CH2)	Used for LTC (timecode) output or audio monitor. From the setting screen, go to [General] -> the [Hardware] tab, and set the output details for each connector using [Audio / LTC Output (CH1/CH2)]. General – Hardware settings ▶ P189

Video I/O board (Elite/Pro/Express)

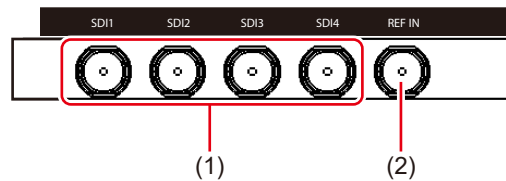

(1)	SDI 1/SDI 2/ SDI 3/SDI 4	The connector to be used varies depending on the selection for [IO Mode]. IO mode list - T2 4K Series (Elite/Pro/Express) ▶ P263
(2)	REF IN	Used to input REF signal.

Video I/O board (Elite Plus/Pro Plus/Express Plus)

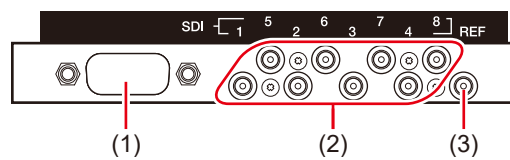

(1)	Terminal not to be used	Not used.
(2)	Upper: SDI 5/SDI 6/SDI 7/SDI 8 Lower: SDI 1/SDI 2/SDI 3/SDI 4	Available terminals differ according to the selection for [IO Mode]. IO mode list - T2 4K Series (Elite Plus/Pro Plus/Express Plus) ▶ P264
(3)	REF	Used for REF signal input.

Remote interface board

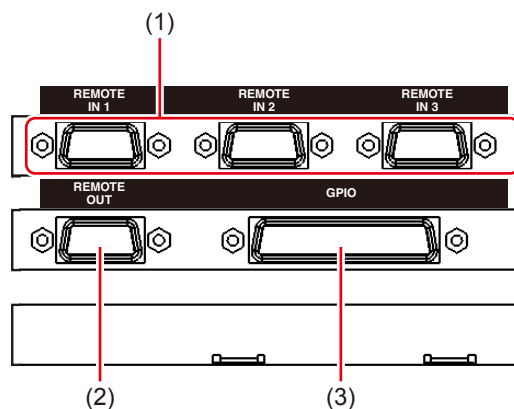

(1)	REMOTE IN 1 / REMOTE IN 2 / REMOTE IN 3	Used to control R1 channel for REMOTE IN 1, P1 channel for REMOTE IN 2, and P2 channel for REMOTE IN 3, using RS422 signal (Sony 9-Pin Protocol). When [[HD/SD] 0 in 3 out] is selected, use REMOTE IN 1 to control the P1 channel, REMOTE IN 2 to control the P2 channel, and REMOTE IN 3 to control the P3 channel.
(2)	REMOTE OUT	Used to control external VTR or other devices using RS422 signal (Sony 9-Pin Protocol).
(3)	GPIO	Used for GPI input/output.

TIP

- The IO modes available on your T2 differ depending on the T2 model type.

IO mode list ▶ P263

Connection/Start-up/Exit

This section describes how to connect peripheral devices to T2, start-up and exit procedures, and switching procedures of front panel mode and workstation mode.

Connecting peripheral devices

The procedure to connect peripheral devices such as external input/output device to T2 is described in this part.

1 Connect a device for Recorder channel input to T2.

Connect a device to the video I/O board or LTC/Monitor audio interface board on the T2 rear panel.

Video I/O board (Elite/Pro/Express) ▶ P32

Video I/O board (Elite Plus/Pro Plus/Express Plus) ▶ P32

LTC/Monitor audio interface board ▶ P32

2 Connect a device for Player channel output to T2.

Connect a device to the video I/O board or LTC/Monitor audio interface board on the T2 rear panel.

Video I/O board (Elite/Pro/Express) ▶ P32

Video I/O board (Elite Plus/Pro Plus/Express Plus) ▶ P32

LTC/Monitor audio interface board ▶ P32

3 If you wish to operate T2 in the workstation mode, connect a mouse, keyboard, and PC monitor to T2.

Connect the mouse and keyboard to the USB port, and connect the PC monitor to the monitor port.

Rear panel ▶ P30

If you wish to operate T2 in the front panel mode, you do not need to connect a mouse, keyboard, and PC monitor.

TIP • A mouse, keyboard, and PC monitor are not included in the product package.

4 Insert the power cable to the inlet of T2.

For T2 4K Elite/T2 4K Elite Plus, insert the cables to the power unit 1 and power unit 2.

For other T2 4K Series products, insert the cable to the power unit 1.

- 5 Use the power cable fixing clamps to secure the power cables.

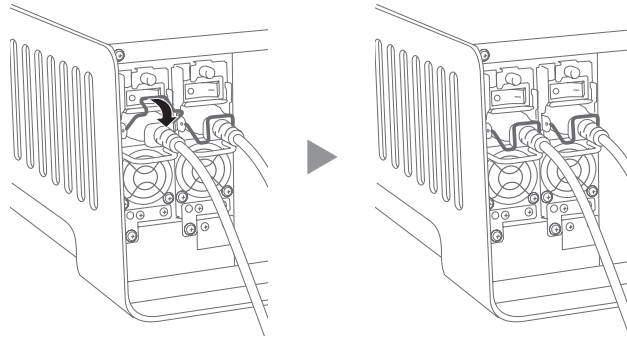

- 6 Connect the power cable to the AC power outlet.

Starting up and exiting T2

Starting up T2

- 1 Turn on the main power switch on the T2 rear panel.

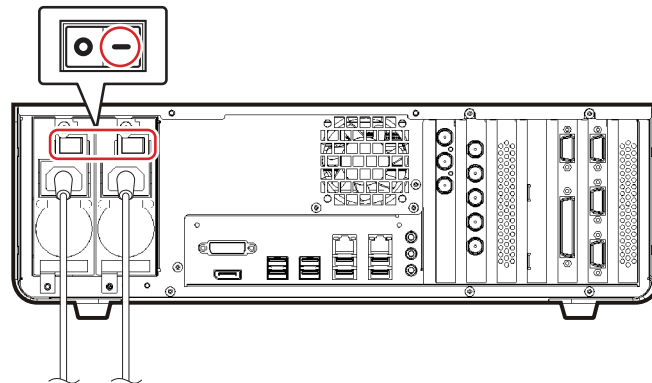

- 2 Turn on the main power switch on the T2 front panel.

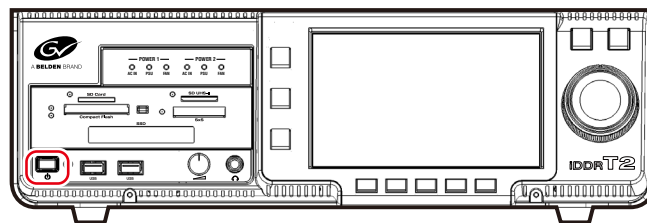

When starting up for the first time, T2 will start up in the front panel mode. The display appears in the 3ch view on the touch screen LCD. Other than the first time, T2 will start up in the previously used operation mode (front panel mode or workstation mode).

TIP

- To start up T2 in the workstation mode, start up T2 in the front panel mode, and then switch to the workstation mode.
Switching from the front panel mode to the workstation mode ► P37

Exiting T2 in the front panel mode

NOTE • Do not forcibly exit T2 by holding down the power switch or turning off the main power switch on the T2 rear panel. A malfunction may occur.

1 Press one of the [R1], [P1], or [P2] button.

You can also perform the operation by tapping [1ch View] or [Bin] on the touch screen LCD.

2 Tap [Menu], and then tap [Tools] -> [Exit].

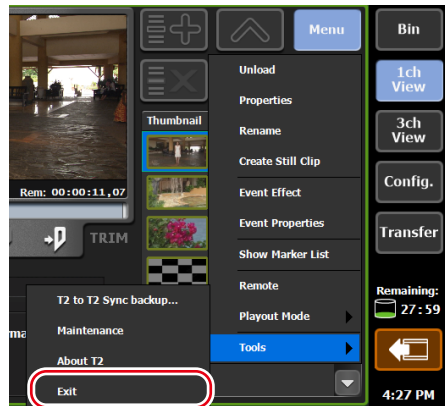

3 Select [Shut Down] from the list and tap [OK].

To restart T2, select [Restart].

NOTE • If you do not use T2 for a long time, turn off the main power switch on the T2 rear panel and unplug the power cord.

Exiting T2 in workstation mode

NOTE • Do not forcibly exit T2 by holding down the power switch or turning off the main power switch on the T2 rear panel. A malfunction may occur.

1 Click [System] on the menu bar, and click [Exit].

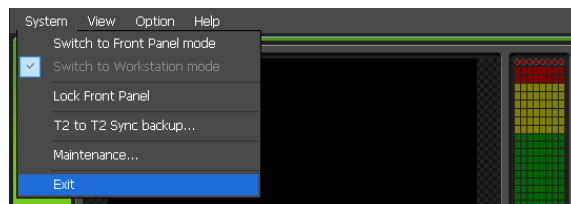

2 Select [Shut Down] from the list and click [OK].

To restart T2, select [Restart].

NOTE • If you do not use T2 for a long time, turn off the main power switch on the T2 rear panel and unplug the power cord.

Switching front panel mode/workstation mode

Switching from the front panel mode to the workstation mode

- 1 On the PC monitor, click [System] on the menu bar, and click [Switch to Workstation mode].

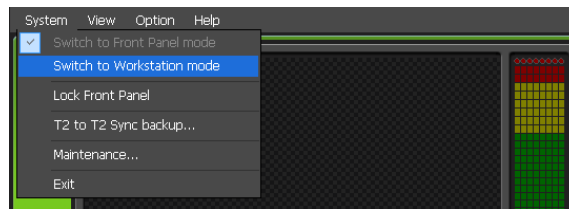

Switching from the workstation mode to the front panel mode

- 1 Tap the touch screen LCD.

You can also switch the mode on the PC monitor, by clicking [System] on the menu bar, and then clicking [Switch to Front Panel mode].

Locking front panel

You can lock the front panel to disable the operations.

- 1 On the PC monitor, click [System] on the menu bar, and click [Lock Front Panel].

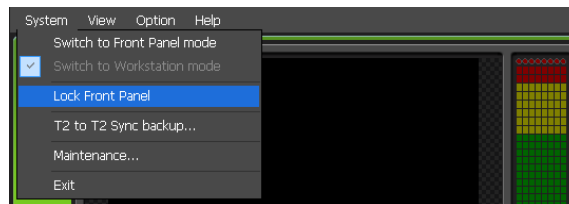

[Lock Front Panel] box is checked while the front panel is being locked. To unlock it, press the [R1], [P1], [P2], and [SHTL/JOG] buttons on the T2 front panel at the same time.

Switching IO mode

This section describes the procedure to switch the input/output mode of T2.

TIP • The IO modes available on your T2 differ depending on the T2 model type.
IO mode list ▶ P263

1 Tap [Config.].



From the setting screen, [General] -> the [Hardware] tab appears.

2 Tap [Settings...] of [IO Mode:].

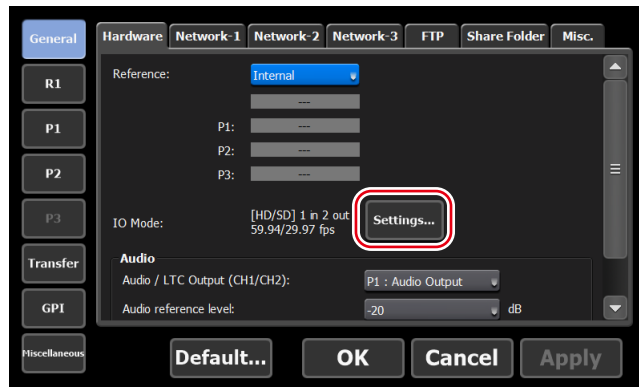

3 Set IO mode in the [IO Mode Setting] dialog box, and tap [OK].

[IO Mode Setting] dialog box ▶ P142

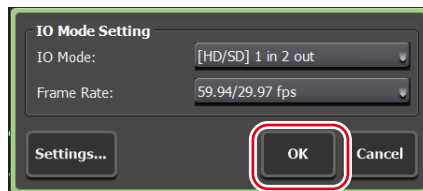

4 Tap [OK].

TIP • In the workstation mode, you can switch the IO mode using the status bar on the lower part of the screen.
Status bar ▶ P162

Assigning a channel for monitor output from the SDI terminal

You can use the SDI terminal on the video I/O board for monitor output. This section describes the procedure to assign an output channel to the SDI terminal to be used for monitor output.

1 Perform steps 1 and 2 of “Switching IO mode”.

Switching IO mode ▶ P38

2 In the [IO Mode Setting] dialog box, tap [Settings...].

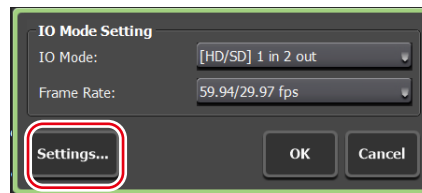

The IO mode detailed settings dialog box appears.

IO mode detailed settings dialog box ▶ P191

3 From the list of SDI terminal setting, select an SDI terminal for which [Monitor output] is indicated as [Type].

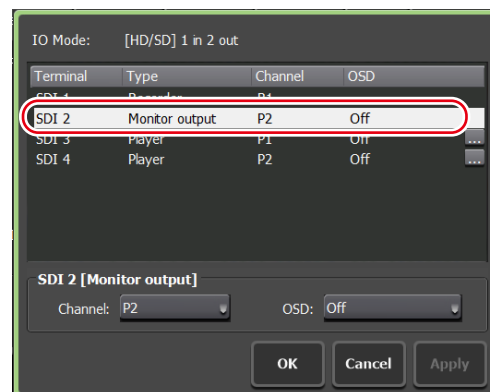

TIP • SDI terminal available for monitor output varies depending on the model type or IO mode of your T2.
IO mode list ▶ P263

- 4 Select a channel for monitor output from the list of [Channel:], and then select ON/OFF of on-screen display from the list of [OSD:].

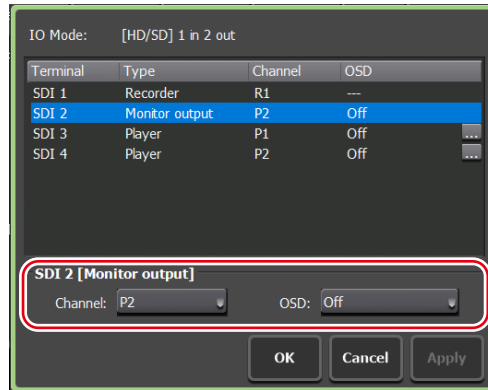

TIP • On-screen display is not available on R1 channel.
Terminal types and available settings ► P192

- 5 Tap [OK] on the IO mode detailed settings dialog box.
- 6 Tap [OK].

Checking the model name and software version

You can check the model name and software version of your T2.

- 1 Press one of the [R1], [P1], or [P2] button.

You can also perform the operation by tapping [1ch View] or [Bin] on the touch screen LCD.

- 2 Tap [Menu] on the touch screen LCD, and tap [Tools] -> [About T2].

The version information of T2 is displayed.

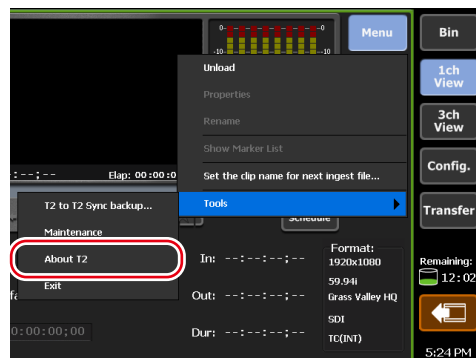

Section 5

Recording

This section describes the recording procedure in the Recorder channel.

Displaying Recorder channel in 1ch view

In the 1ch view of the Recorder channel, various operations for recording are available.

1 Press the [R1] button.

The display switches to the 1ch view of the Recorder channel, and the [R1] button lights in green.

You can also switch by tapping [1ch View] and then tapping the Recorder channel tab.

You can use the operation buttons on the lower part of the touch screen LCD, to start and end of recording.

➤ Recorder channel – 1ch view

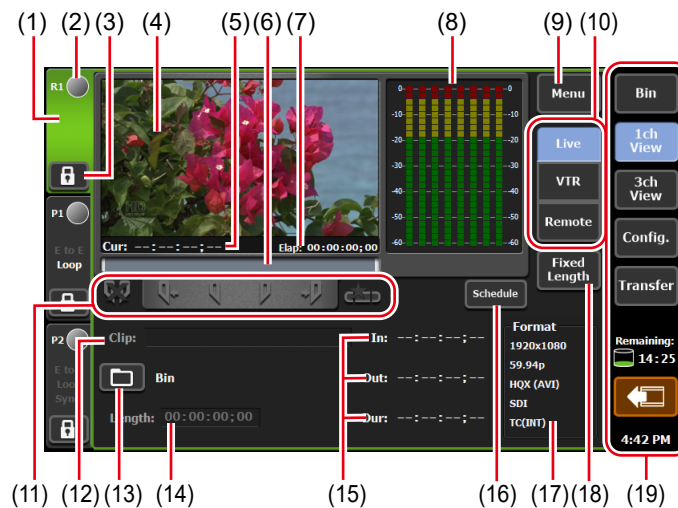

(1)	Recorder channel tab	By tapping, selects and highlights the Recorder channel.
(2)	Status	Indicates the recording progress status.

(3)	[Locked]	Locks Recorder channel operations. While the operations are locked, [Locked] and [R1] buttons light in red. Tapping it again releases the lock.
(4)	Preview	Displays the video currently inputted. Tapping the preview displays in the full screen view.
(5)	[Cur:]	Indicates the current timecode inputted.
(6)	Scrubbing bar	Indicates the recording progress status.
(7)	[Elap:]	Indicates the elapsed time of recording by timecode display.
(8)	Audio level display	Displays the audio playback level.
(9)	[Menu]	Displays menu such as properties of clip and rename, unload, set the clip name for next ingest file, etc.
(10)	Recording mode	Switches the recording mode (Recorder-live mode /Recorder-VTR mode/Recorder-remote mode).
(11)	Operation buttons	Operation buttons of Recorder channel ▶ P43
(12)	[Clip:]	Displays the name of the clip currently recorded.
(13)	[Saving destination]	Sets the saving destination of the recorded clip. The destination bin name is displayed in the right. If the saving destination is an external storage, it changes to green.
(14)	[Length:]	If [Fixed Length] is on, sets the time length (duration) from the start point to the end point of recording by tapping the timecode.
(15)	[In:]/[Out:]/[Dur:]	Indicates the timecode of In/Out points and duration. In the Recorder-VTR mode, you can set In or Out point by tapping the timecode of [In:] or [Out:].

(16)	[Schedule]	In the Recorder-live mode, automatically starts recording operation at a specified time, and ends it at a specified time. In the front panel mode, allows to switch on/off of schedule and to display the schedule list. To add, edit, or delete schedules, use the workstation mode. Recorder-live mode / schedule mode▶P137
(17)	[Format:]	Displays the video size, frame rate, input settings, port used for input, source TC (TC (LTC)/SDI (VITC)/INT), etc.
(18)	[Fixed Length]	By tapping to set it on, automatically ends recording after the duration specified in [Length:] has passed.
(19)	1ch view/3ch view/ bin/transfer screen common area	1ch view/3ch view/bin/transfer screen common area▶P44

➤ Operation buttons of Recorder channel

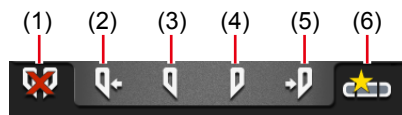

(1)	[Clear (In/Out)]	Clears set In/Out points.
(2)	[Cue(In)]* ¹	Moves the VTR to the In point.
(3)	[Mark(In)]	Sets In point to the current position.
(4)	[Mark(Out)]	Sets Out point to the current position.
(5)	[Cue(Out)]* ¹	Moves the VTR to the Out point.
(6)	[Create Subclip]* ²	Creates a sub clip between In-Out points set while recording, and saves it as highlight.

*1 Only for Recorder-VTR mode.

*2 Only for Recorder-live mode. However, if the video being recorded is saved to an external media/storage, a sub clip cannot be created.

➤ 1ch view/3ch view/bin/transfer screen common area

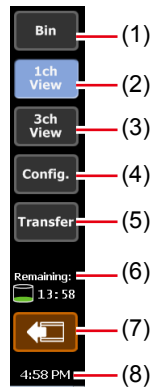

(1)	[Bin]	Display the bin view. Managing contents in the bin▶P76
(2)	[1ch View]	Switches the currently selected channel to 1ch view.
(3)	[3ch View]	Switches to 3ch view.
(4)	[Config.]	Displays the setting screen. Displaying the setting screen▶P188
(5)	[Transfer]	Display the transfer screen. Checking the transfer status▶P59
(6)	Remaining HDD (remaining time)	Displays the estimated recording time available on HDD. When the remaining capacity reduces, the icon is displayed in red.
(7)	[Remove Device]	Displayed when a removable drive such as USB removable media, XDCAM, P2, etc. is connected. By tapping, disconnects the removable media. Removing removable media▶P61
(8)	Time	Displays the current time. Tapping this part displays the date and time setting dialog box that enables to change the set time. Date and time setting dialog box▶P206

NOTE • If the  icon appears in 1ch view/3ch view/bin/transfer screen common area, there is a problem with the data drive. Consult the support.

Selecting Recorder channel in 3ch view

When [[HD/SD] 1 in 2 out] is selected in 3ch view, you can view the R1, P1, and P2 channels simultaneously.

In 3ch view of the Recorder channel, you can use the operation buttons on the lower part of the touch screen LCD, to start and end of recording.

1 Tap [3ch View].

The display switches to 3ch view.

2 Tap the Recorder channel tab.

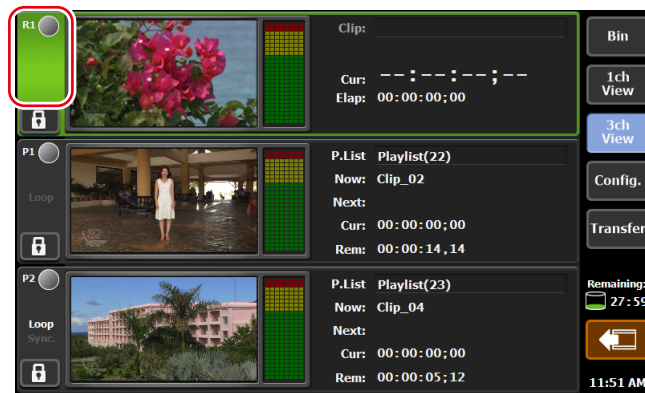

Recorder channel is selected and highlighted.

➤ Recorder channel – 3ch view

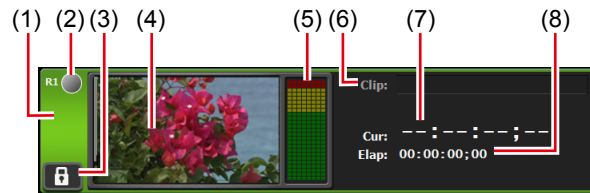

(1)	Recorder channel tab	By tapping, selects and highlights the Recorder channel.
(2)	Status	Indicates the recording progress status.
(3)	[Locked]	Locks Recorder channel operations. While the operations are locked, [Locked] and [R1] buttons light in red. Tapping it again releases the lock.
(4)	Preview	Displays the video currently inputted.
(5)	Audio level display	Displays the audio playback level.
(6)	[Clip:]	Indicates the name of the clip.

(7)	[Cur:]	Indicates the current timecode inputted.
(8)	[Elap:]	Indicates the elapsed time of recording by timecode display.

Recording by VTR control (Recorder-VTR mode)

The procedure to control VTR from your T2 and perform recording is described in this part.

Set the connection information of the VTR used for recording or the video format for capturing beforehand.

General – Hardware settings ▶ P189

Recorder settings ▶ P207

Transfer – common settings ▶ P219

If necessary, make settings in the setting screen according to the environment in use.

Settings ▶ P188

- TIP**
- In the workstation mode, you can import the batch capture list to your T2 and record sources at once.
Recording sources at once (batch capturing) ▶ P176
 - The VTR can be controlled by using your T2 as a controller and via AMP command or BVW command.
Controlling an external device from T2 with AMP/BVW (Recorder-VTR mode) ▶ P238
AMP command list ▶ P265
BVW command list ▶ P278

1 Press the [R1] button.

Recorder channel is displayed in 1ch view. The video from the external input device is displayed in the preview.

Recorder channel – 1ch view ▶ P41

2 Tap [VTR].

The mode switches to the Recorder-VTR mode.

3 Tap [Saving destination], select the saving destination of the clip to record, and then tap [OK].

Saving destination dialog box ▶ P212

4 Play back the video to record and tap [Mark(In)] and [Mark(Out)] to specify the recording range (In/Out points).

Playing back video ▶ P97

- TIP**
- You can also specify the timecode by tapping the entry area of [In:] and [Out:].
 - You can also specify the time lapse from the start point of recording (duration) to automatically end the recording. Tap [Fixed Length], tap the entry area of [Length:], and enter the timecode.

Recorder channel – 1ch view ► P41

5 Press the [Rec] button.

The recording starts at the specified In point. The recording automatically ends at the specified Out point.

You can set the clip name by tapping the entry area of [Clip:] while recording. To end the recording in the middle, press the [Stop] button.

After the recording ends, the recorded clip is saved in the bin selected in step 3.

- TIP**
- The video currently recorded in the Recorder channel can be loaded and played on the Player channel.
Loading and playing back video currently recorded (chasing playback) ► P99
 - The video currently recorded on the Recorder channel can be output from P1/P2 channel with active-through output.
Outputting currently recorded video with active through (E to E mode) ► P100
 - To check the properties of the clip currently recorded, tap [Menu] and then tap [Properties] on the 1ch view of the Recorder channel.
 - To change the name of the clip currently recorded, tap [Menu] and then tap [Rename] on the 1ch view of the Recorder channel.
 - Markers can be added on a clip being recorded.
Adding marker ► P125
 - To unload the video after recording, tap [Menu] and then tap [Unload] on the 1ch view of the Recorder channel.
 - To set the clip name for next ingest file, tap [Menu] and then tap [Set the clip name for next ingest file...] on the 1ch view of the Recorder channel. If the name of the clip to be recorded next has been set in the Recorder channel, the clip name setting for the next recorded clip is prioritized.
Setting of ingesting dialog box ► P145

Recording live video (Recorder-live mode)

The procedure to record live video from an external device is described in this part.

Set the connection information of the external device used for recording or the video format for capturing beforehand.

General – Hardware settings▶P189

Recorder settings▶P207

Transfer – common settings▶P219

If necessary, make settings in the setting screen according to the environment in use.

Settings▶P188

You can also set to automatically start recording operation at a specified time and end it at a specified time. (Only available in the workstation mode.)

Recorder-live mode / schedule mode▶P137

TIP

- The name of the clip to be recorded can be specified. You can set the naming rule and specify the name of the clip to be recorded in the next.

Recorder channel – 1ch view▶P41

Setting of ingesting dialog box▶P145

- You can also record video from a device that cannot allow deck control in the same procedure. Find the start point of the video for recording beforehand.

1 Press the [R1] button.

Recorder channel is displayed in 1ch view. The video from the external input device is displayed in the preview.

Recorder channel – 1ch view▶P41

2 Tap [Live].

The mode switches to the Recorder-live mode.

3 Tap [Saving destination], select the saving destination of the clip to record, and then tap [OK].

Saving destination dialog box▶P212

4 If necessary, play the video from the external device and press the [Rec] button on T2.

The recording starts.

You can set the clip name by tapping the entry area of [Clip:] while recording.

TIP

- An important part in the recorded video can be saved in another clip as highlight. Tap [Mark(In)] and [Mark(Out)], and then tap [Create Subclip]. However, if the video being recorded is saved to an external storage, a sub clip cannot be created.
- You can also specify the time lapse from the start point of recording (duration) to automatically end the recording. Tap [Fixed Length], tap the entry area of [Length:], and enter the timecode.
- The video currently recorded in the Recorder channel can be loaded and played on the Player channel.

Loading and playing back video currently recorded (chasing playback) ► P99

- The video currently recorded on the Recorder channel can be output from P1/P2 channel with active-through output.

Outputting currently recorded video with active through (E to E mode) ► P100

- To check the properties of the clip currently recorded, tap [Menu] and then tap [Properties] on the 1ch view of the Recorder channel.
- To change the name of the clip currently recorded, tap [Menu] and then tap [Rename] on the 1ch view of the Recorder channel.
- Markers can be added on a clip being recorded.

Adding marker ► P125

5 After recording the necessary video, press the [Stop] button on T2.

After stopping recording, the recorded clip is saved in the bin selected in step 3.

TIP

- To unload the video after recording, tap [Menu] and then tap [Unload] on the 1ch view of the Recorder channel.
- To set the clip name for next ingest file, tap [Menu] and then tap [Set the clip name for next ingest file...] on the 1ch view of the Recorder channel. If the name of the clip to be recorded next has been set in the Recorder channel, the clip name setting for the next recorded clip is prioritized.

Setting of ingesting dialog box ► P145

Import/Export

This section describes the procedure to import a media file from a removable media or network drive and to export contents edited in your T2.

Importing a media file

Displaying the [Browse] tab

Import of media files from a removable media such as USB removable device, XDCAM, P2, and from a network drive to your T2 is performed from the [Browse] tab.

1 Tap [Bin].

The bin view appears.

2 Tap the [Browse] tab.

➤ [Browse] tab

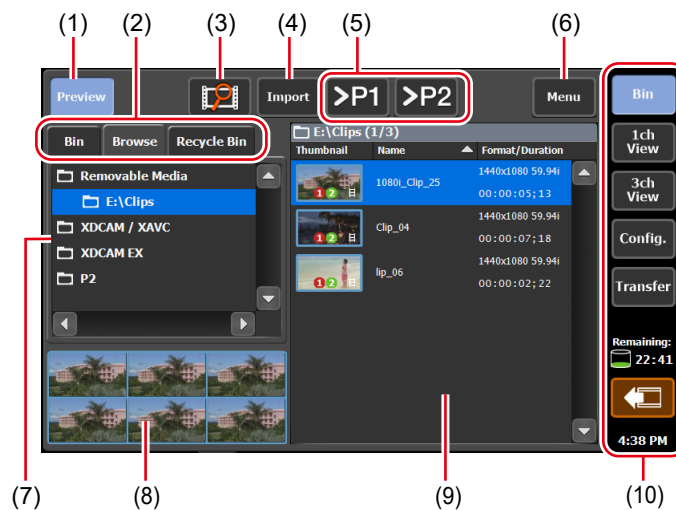

(1)	[Preview]	Switches on/off of the preview (filmstrip).
(2)	View switching tab	Switches between [Bin] tab/[Browse] tab/[Recycle Bin] tab.

(3)	[New connection]	When a removable media is connected to T2, you can select a folder to display in the [Browse] tab.
(4)	[Import]	Imports the selected media file to T2 as a clip.
(5)	[>Px]	Loads the selected media file to the Player channel. You can play and check the video without importing to T2 as a clip. However, the playback speed depends on the specifications of the connected removable media.
(6)	[Menu]	Displays the related menu.
(7)	Removable media list	Displays the media or folders in the removable media connected to T2. The selected folder is highlighted in blue.
(8)	Filmstrip display	By tapping [Preview] and set it on, displays the contents in the media file in filmstrip with six frames.
(9)	Media file list	Displays the list of media files in the drive selected from the removable media list. The selected media file is highlighted in blue.
(10)	1ch view/3ch view/bin/transfer screen common area	1ch view/3ch view/bin/transfer screen common area▶P44

TIP • The IO modes available on your T2 differ depending on the T2 model type.
IO mode list▶P263

Displaying media file in removable media

Media files in a removable media such as USB removable device, XDCAM, P2, etc. can be displayed without importing to T2.

NOTE

- When using XDCAM, XDCAM EX, XAVC, XAVC S, or P2 device, install the driver in the maintenance mode before connecting the device to T2. For more information about the maintenance mode, refer to the T2 Service Manual.
Operation-ensured driver versions for XDCAM/XDCAM EX/XAVC/XAVC S ▶ P256
Operation-ensured driver version for P2 ▶ P256

TIP

- For details on the supported formats, see “Appendix”.
Supported Formats ▶ P257
- If you make settings of the network drive in the workstation mode, you can display media files in the network drive from the [Browse] tab.
Displaying media files in network drive ▶ P178

1 Connect a removable media to your T2 and insert medium.

For T2 4K Elite/T2 4K Elite Plus, cards can be directly inserted into the slots of the media card reader. When the media is recognized by T2, the indicator on the left of the card slot lights up in green.

Media card reader (T2 4K Elite/T2 4K Elite Plus only) ▶ P28

2 Tap [Import].



The screen switches to the [Browse] tab.

NOTE

- If it does not switch to the [Browse] tab, switch manually.

3 Tap [New connection] and select a medium type.

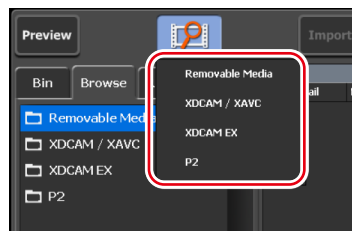

4 Select a drive, and then tap [OK].

Media file list including media files appears.

TIP • To update information in the removable media, tap [Menu], and then tap [Refresh].

Playing media file in removable media

You can load media files in a removable media to T2 and play them.

NOTE • The system is under heavy load during playback of clips in removable media. It is recommended that you import the file to your T2 and play it.

1 Select a drive in the [Browse] tab and display the media file.

Displaying media file in removable media ► P52

2 Select a media file and tap [>Px].

While another clip is loaded, a confirmation message appears. Tap [Yes] to unload the clip.

The media file is loaded to the Player channel.

TIP • You can also load the file to the selected channel by tapping the media file two times.

3 Press the [Play] button.

Playing back video ► P97

TIP • The following operation are available on the media files loaded to the Player channel.

- Playback operation using the T2 front panel control buttons
- Setting of In and Out points and moving to In or Out point
- Setting markers, moving to markers

NOTE • Depending on the specifications of the connected removable media, playback operation may not catch up.

- The following operations are not available on the media files loaded to the Player channel.
 - Import of video between set In-Out points
 - Import of added markers
 - Gain adjustment of audio level
 - Tag editing (workstation mode only)
 - Sync playback (pairing)
 - Adding to playlist
 - Creating sub clips

If you add files to playlist, create sub clips or create still clip, import the media file before you perform the operation.

Checking the properties of media file

The procedure for checking the properties of media file is described in this part.

1 Select a drive in the [Browse] tab and display the media file.

Displaying media file in removable media ► P52

2 Select a media file, tap [Menu], and then tap [Properties].

The properties of media file is displayed.

► Properties of media file

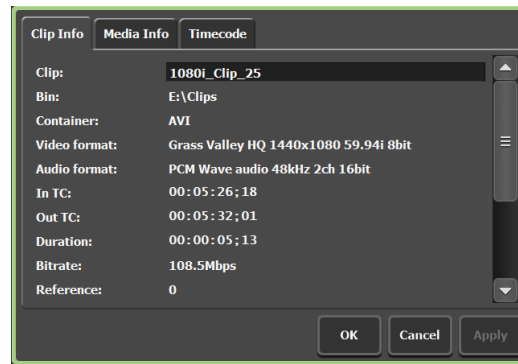

<p>[Clip Info] tab</p>	<p>Displays the clip information. You can check the clip name, format, In/Out points timecode, length, alpha channel presence, date of creation, bitrate, etc. Tapping the entry area allows to change the clip name. Checking [Locked] locks the clip from editing.</p>
<p>[Media Info] tab</p>	<p>The information of media file is displayed. You can check the file path, number of clips and playlists linked to the media file, size, In/Out points timecode, etc. Tapping [Details...] allows to check the details of the clips linked to the media file.</p>
<p>[Timecode] tab</p>	<p>Specifies start timecode. To use the start timecode of a media file, select [Source]. To specify a start timecode, select [Specify Start Time], tap the entry area, and enter timecode.</p>

3 Tap [OK].

Changing media file list display

You can switch the display of the media file list between icon display and text display.

- 1 Tap [Menu], and then tap [View].
- 2 Tap [Icon View] or [Text View].

Importing a media file

The procedure for importing media file to T2 is described in this part. At the time of import, you can set whether to import the file in the native format or in a converted format such as Grass Valley HQX AVI. The import operation will be easier if the format for the imported file and other setting items have been set beforehand.

Transfer settings►P219

If necessary, make settings in the setting screen according to the environment in use.

Settings►P188

TIP

- For more information about the file formats that can be imported, see “Appendix”.
- Supported Formats►P257**
- If data is imported as the native format, XDCAM, XDCAM EX, XAVC, XAVC S, and P2 sources will be copied with folders and files that are necessary for native format playback on T2.
 - You can convert a file to Grass Valley HQX AVI after importing it as the native format.

Converting contents to other formats►P82

- Still image files are converted to Grass Valley HQX AVI and imported.
- The system will import files that contain transparency information after converting them to Grass Valley HQX AVI.
- If a file that contains the following settings in the metadata of XDCAM or P2 source is imported, it will be imported as markers for T2.
 - Essence marks in the metadata of XAVC or XAVC S
 - Essence marks in the metadata of XDCAM or XDCAM EX
 - Memo list in the metadata of P2

Note that the markers set with T2 cannot be reflected in the original media file.

- 1 Select a drive in the [Browse] tab and display the media file.

Displaying media file in removable media►P52

2 Select a media file, tap [Import], and then tap [Import...].

The Import dialog box appears.

TIP • Dragging on the media file selects multiple media files.

➤ **Import dialog box**

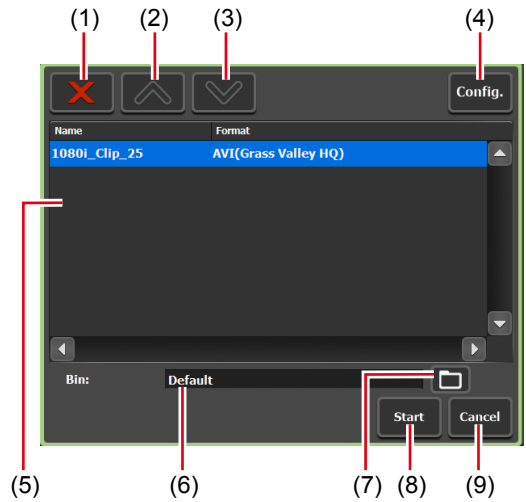

(1)	[Delete]	Deletes the selected file from the import list.
(2)	[UP]	Moves up the selected file.
(3)	[DOWN]	Moves down the selected file.
(4)	[Config.]	Displays the setting screen. Sets the file format after imported.
(5)	Import list	Displays the list of the files to be imported. [Format] shows the formats of files to be imported.
(6)	[Bin:]	Displays the saving destination bin for the imported media files.
(7)	[Select Import Destination Bin]	Selects the saving destination bin for the imported media files.
(8)	[Start]	Starts import.
(9)	[Cancel]	Closes the import dialog box.

3 Tap [Config.].

If conversion of the format of the file to import is not necessary, you do not need to change the settings in the setting screen. Proceed to step 6.

4 Tap the tab of the format of the media file.

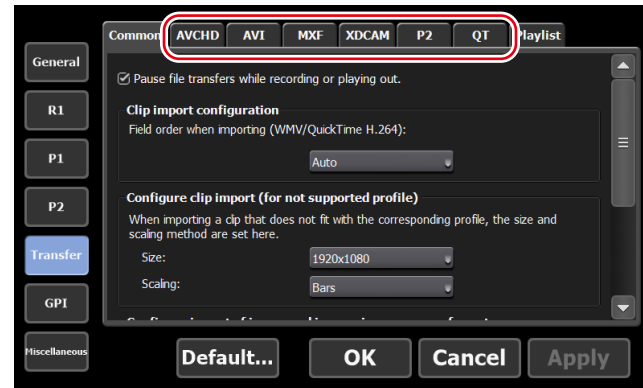

For example, if the media file to import is XDCAM format, tap the [XDCAM] tab. If it is an MXF single file, tap the [MXF] tab.

5 From the [File format after import:] list, select a post-import format and then tap [OK].

6 In the import dialog box, tap [Select Import Destination Bin], select a bin, and tap [OK].

7 Tap [Start].

Import starts. You can check the progress in the transfer screen.

Checking the transfer status ► P59

NOTE

- By default, the system will pause any transfer and conversion during a recording or playback. If you want transfer and conversion to be performed even during a recording or playback, change the setting by [Transfer] -> [Common] on the setting screen. Unchecking [Pause file transfers while recording or playing out.] enables transfer and conversion even during a recording or playback. However, if this option is unchecked, the recording/playback operations may not be performed normally, therefore, we recommend that you use the system with this option checked.

Transfer – common settings ► P219

Importing still images with serial numbers as a sequence clip

Still images with serial numbers can be imported as a single sequence clip (in Grass Valley HQX AVI).

If necessary, make settings in the setting screen according to the environment in use.

Settings ► P188

- NOTE**
- If a file has a name that has characters followed by numerics, such as Clip1234.jpg, it will be recognized as a still image file with a sequential number.
 - If some of the files have different extensions, or if files with added alpha channel and those without alpha are mixed, the import of the still images with serial numbers will be canceled.

1 Select a drive in the [Browse] tab and display the media file.

Displaying media file in removable media ► P52

2 Select the first file in the serial numbers, tap [Import], and then tap [Import (Sequence)...].

The Import dialog box appears.

Import dialog box ► P56

3 Tap [Config.].

4 In [Configure import of image and images in a sequence format], select a post-import format and then tap [OK].

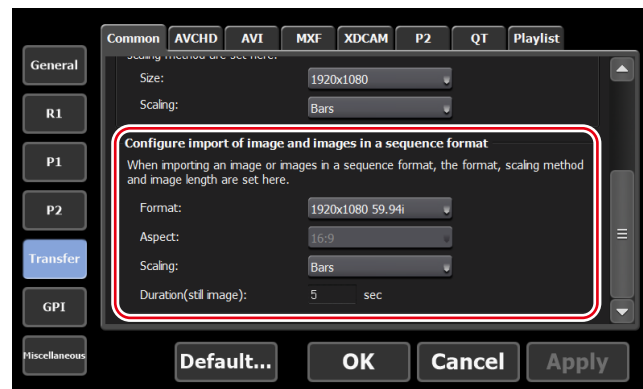

5 In the import dialog box, tap [Select Import Destination Bin], select a bin, and tap [OK].

6 Tap [Start].

Import starts. You can check the progress in the transfer screen.

Checking the transfer status ► P59

NOTE

- By default, the system will pause any transfer and conversion during a recording or playback. If you want transfer and conversion to be performed even during a recording or playback, change the setting by [Transfer] -> [Common] on the setting screen. Unchecking [Pause file transfers while recording or playing out.] enables transfer and conversion even during a recording or playback. However, if this option is unchecked, the recording/playback operations may not be performed normally, therefore, we recommend that you use the system with this option checked.

Transfer – common settings ► P219

Checking the transfer status

You can check the status of file transfer or conversion (jobs) in the transfer screen.

1 Tap [Transfer].

► **Transfer screen**

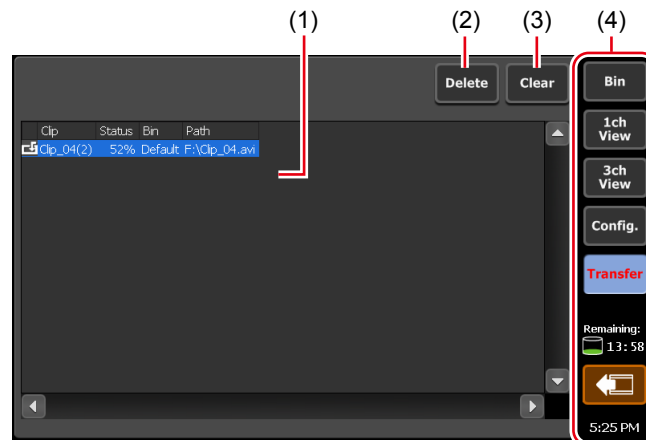

(1)	Job list	<p>Displays the list of jobs.</p> <p>[Clip] Indicates the name of the clip.</p> <p>[Status] Indicates the job progress status.</p> <p>[Bin] Indicates the bin name.</p> <p>[Path] Indicates media file path and file name.</p>
(2)	[Delete]	<p>Deletes selected jobs. If you tap [Delete] while executing a job, the job will be canceled.</p>
(3)	[Clear]	<p>Deletes all jobs from the job list.</p>
(4)	1ch view/3ch view/bin/transfer screen common area	<p>1ch view/3ch view/bin/transfer screen common area▶P44</p>

Removing medium in removable media

The procedures to remove a medium in the removable media connected to your T2 (such as XDCAM professional disc, SxS memory card, and P2 card), and to disconnect the folder in the USB removable device are described in this part.

- 1** Select a drive in the [Browse] tab.
- 2** Tap [Menu], and then tap [Disconnect].
- 3** A message appears. Tap [OK].
- 4** Remove the medium (XDCAM professional disc, SxS memory card, or P2 card) from the removable media.

If you want to disconnect your T2 from the removable media, disconnect the removable media.

Removing removable media▶P61

Removing removable media

The procedure to remove a removable media such as USB removable device, XDCAM, XDCAM EX, XAVC, XAVC S, P2, etc. from T2 is described in this part.

Before removing the removable media you need to disconnect the medium or file in the media.

Removing medium in removable media ► P60

1 Tap [Remove Device].

You can operate it from the bin view, 1ch view, 3ch view, and transfer screen.

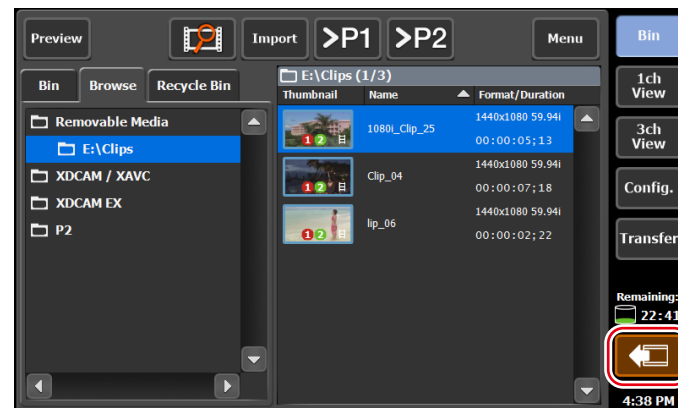

2 Select a removable media, and then tap [Remove].

3 A message appears. Tap [Yes].

4 Remove the removable media from T2.

For T2 4K Elite/T2 4K Elite Plus, be sure that the indicator on the left of the card slot is turned off before removing the media card from the media card reader slot.

TIP • If the media indicates a status that it is being used and you cannot remove it even after tapping [Remove], turn off the T2 and remove the removable media.

Importing a media file on WatchFolder

A specified folder can be monitored as a WatchFolder (shared folder), and when a media file is placed on the WatchFolder, importing starts automatically. Folders not only in the internal storage but also in an external media/storage can be monitored as a WatchFolder.

The import operation will be easier if the format for the imported file and other setting items have been set beforehand.

Transfer settings ► P219

If necessary, make settings in the setting screen according to the environment in use.

Settings▶P188

- 1 Tap [General], and then tap the [Share Folder] tab in the setting screen.

General – Share Folder settings▶P199

- 2 Select a imported bin from list of [Destination].
- 3 Specify the folder to be monitored as a WatchFolder.

To specify a folder in the internal storage as a WatchFolder, check [Set folder in local storage as watch folder]. A folder named “WatchFolder” will be created and shared as a WatchFolder.

To specify a folder in an external media or storage as a WatchFolder, check [Set external folder in external media / storage as watch folder.] and specify a folder.

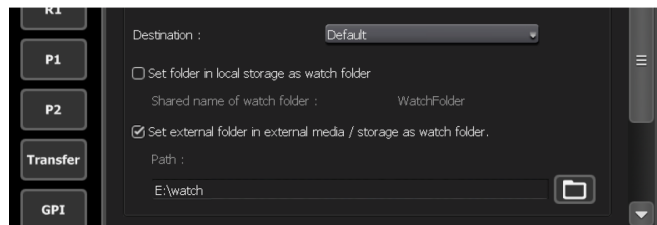

- 4 Tap [OK].

The WatchFolder will be enabled.

- 5 Access the WatchFolder from another PC.

To access a WatchFolder in the internal storage, IP address setting and user account are required. To set an IP address, follow steps 1 to 8 in “Uploading files to T2/downloading files from T2”.

Uploading files to T2/downloading files from T2▶P69

General – Share Folder settings▶P199

- 6 Copy a media file that you wish to import to the WatchFolder.

After copying of the media files has completed, import starts.

Media files copied to the WatchFolder will be deleted after the import operation.

- NOTE**
- If you copy files that cannot be imported to the WatchFolder in the internal storage, the files that cannot be imported will be deleted.
 - If you copy files that cannot be imported to the WatchFolder in the external storage, the files that cannot be imported will not be deleted.
 - If you copy media files to the WatchFolder of the internal storage, recording or playback may be affected.
 - If writing does not catch up with importing, recording will stop.

Exporting a file

Exporting contents to a file

The procedure to export a clip or playlist registered in the bin of your T2 to a file is described in this part.

At the time of export, you can set whether to export the file in the native format or in a converted format.

The export operation will be easier if the format for the exported file and other setting items have been set beforehand.

Transfer settings▶P219

If necessary, make settings in the setting screen according to the environment in use.

Settings▶P188

- NOTE**
- For XDCAM, XDCAM EX, XAVC, XAVC S, and P2 sources, only the files in each folder that are related to the selected files to be imported will be copied. If a file imported as its native format is exported with no conversion, the exported file may not be properly handled depending on the device.

- TIP**
- For important notes on exporting, see “Appendix”.
Notes on export and growing clip editing▶P260
 - When exporting a Grass Valley HQX AVI or Grass Valley HQX MXF file (including the case when a Grass Valley HQX AVI file is converted to Grass Valley HQX/XDCAM/Apple ProRes/Avid DNxHD MXF file and output), the exported file contains the video trimmed between the set In and Out points. When exporting other format files, the whole file is exported.

TIP

- You can convert Grass Valley HQX AVI files to some specific formats to export.

Transfer – AVI settings ► P223

- When exporting a playlist to a file, the file is converted with the following features.
 - If several formats are contained, they are converted in one file.
 - A timecode set in a playlist or event properties can be retained in each frame of the converted file.
 - When exporting files in Grass Valley HQX AVI format, the profile (size and frame rate) of the converted file is same as the profile of the playlist.
 - When exporting files in MXF or MOV, files are converted according to the settings of [Advanced AVI transcoding settings] in [Transfer] -> [AVI] on the setting screen.

Transfer – AVI settings ► P223

- The audio gain set for the event in the playlist is maintained in the converted clip.
- Audio is converted into PCM 48kHz 24bit 8ch.
- You cannot export a playlist that includes a place holder event.
- If you export (or convert) a Grass Valley HQX AVI file, Grass Valley HQX MXF file, or playlist, the marker information set with T2 will be recorded to the exported data.

1 Display the contents in the [Bin] tab.

Displaying the [Bin] tab ► P76

2 Select an item, tap [Export], and then tap [Export Media Files...].
A message related to export appears. Read the message, and then tap [OK].
The Export dialog box appears.

➤ Export dialog box

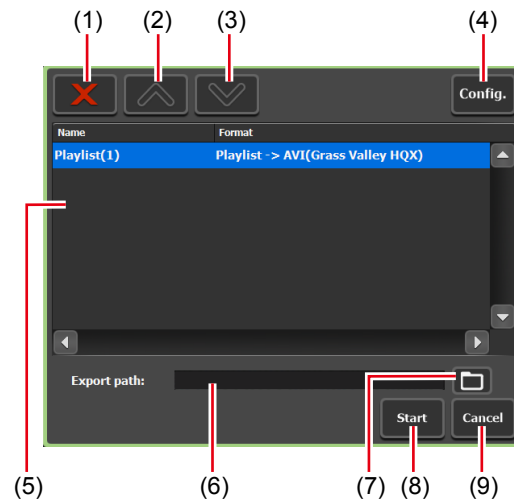

(1)	[Delete]	Deletes the selected file from the export list.
(2)	[UP]	Moves up the selected file.
(3)	[DOWN]	Moves down the selected file.
(4)	[Config.]	Displays the setting screen. Sets the file format and others after exported.
(5)	Export list	Displays the list of the files to be exported. [Format] shows the formats of files to be exported.
(6)	[Export Path:]	Displays the saving destination of the files to be exported.
(7)	[Select Export Folder]	Selects the saving destination of the files to be exported.
(8)	[Start]	Starts export.
(9)	[Cancel]	Closes the export dialog box.

TIP • If you export to XDCAM drive (SONY PDW-U1, PDW-U2), you tap [Export], and then tap [Export Media Files to XDCAM Drive...].

3 If necessary, tap [Config.] to set the file format after conversion.

- If conversion is not necessary, you do not need to change the settings in the setting screen. Proceed to step 4.

- To convert a Grass Valley HQX AVI file to a specific format to export, tap the [AVI] tab and check [Execute transcoding when exporting AVI file.]. Make settings in [Advanced AVI transcoding settings], and tap [OK].

Transfer – AVI settings►P223

- To export a playlist, tap the [Playlist] tab. From the [File format after export:] list, select a post-import format and then tap [OK].

Transfer – Playlist settings►P229

- 4 In the export dialog box, tap [Select Export Folder], select a folder, and tap [OK].

- 5 Tap [Start].

Export starts. You can check the progress in the transfer screen.

Checking the transfer status►P59

NOTE • By default, the system will pause any transfer and conversion during a recording or playback. If you want transfer and conversion to be performed even during a recording or playback, change the setting by [Transfer] -> [Common] on the setting screen. Unchecking [Pause file transfers while recording or playing out.] enables transfer and conversion even during a recording or playback. However, if this option is unchecked, the recording/playback operations may not be performed normally, therefore, we recommend that you use the system with this option checked.

Transfer – common settings►P219

Exporting contents in T2 format

If you export playlists or clips to the T2 format (TWF file), you can import them to another T2 with the playlist or clip information (In/Out points, markers, effect, event list, ancillary data, etc.) retained.

TIP • For important notes on exporting, see “Appendix”.
Notes on export and growing clip editing►P260

- TWF file is a file in the ZIP format. If you change the extension of the TWF file to “*.zip” and extract it with software for ZIP, you can extract it as a media file.
- You can send/receive playlists and clips directly from T2 to other T2 via FTP.

Transferring a file to other T2►P67

- 1 Display the contents in the [Bin] tab.

Displaying the [Bin] tab►P76

- 2 Select an item, tap [Export], and then tap [Export in T2 Format (TWF Files)...].

A message related to export to other T2 appears. Read the message, and then tap [OK].

The Export dialog box appears.

Export dialog box►P65

- 3 In the export dialog box, tap [Select Export Folder], select a folder, and tap [OK].

- 4 Tap [Start].

Export starts. You can check the progress in the transfer screen.

Checking the transfer status►P59

Transferring a file to other T2

Overview of file transfer function from T2 to T2

You can transfer media files from T2 to other T2 via FTP. If you export media files from source T2 to the FTP server of target T2, you can use the files from the [Bin] tab on target T2 without import operations.

Registering the FTP server connection settings

Register the FTP server connection setting of the transfer target T2 on the transfer source T2.

- TIP**
- Set target T2 to be used as the FTP server beforehand. Perform steps 1 to 8 in “Uploading files to T2/downloading files from T2” on target T2.

Uploading files to T2/downloading files from T2►P69

- 1 Tap [Config.].

You can operate it from the bin view, 1ch view, 3ch view, and transfer screen.

- 2 Tap [General], and then tap the [FTP] tab.

- 3 Tap [Add...].

The FTP destination setting dialog box appears.

FTP destination setting dialog box►P198

- 4 Configure the FTP server settings of T2 (destination), and then tap [OK].

In the export dialog box, you can tap [Select Export Folder] to select the FTP server of T2 (destination).

Exporting a file from T2 to T2

Configure the FTP server settings of T2 (destination) before you perform export operation.

Registering the FTP server connection settings ► P67

The export operation will be easier if the format for the exported file and other setting items have been set beforehand.

Transfer settings ► P219

Make settings in the setting screen according to the environment in use.

Settings ► P188

TIP • For important notes on exporting, see “Appendix”.
Notes on export and growing clip editing ► P260

1 Display the contents in the [Bin] tab.

Displaying the [Bin] tab ► P76

2 Select an item and tap [Export], and then tap [Export Media Files...] or [Export in T2 Format (TWF Files)...].

NOTE • Playlists or clips composed of multiple files cannot be exported as the original formats. Export them in the T2 format.

A message related to export or a message related to export to other T2 appears. Read the message, and then tap [OK].

The Export dialog box appears.

Export dialog box ► P65

3 If necessary, tap [Config.] to set the file format after conversion.

- If conversion is not necessary, you do not need to change the settings in the setting screen. Proceed to step 4.
- To convert a Grass Valley HQX AVI file to a specific format to export, tap the [AVI] tab and check [Execute transcoding when exporting AVI file.]. Make settings in [Advanced AVI transcoding settings], and tap [OK].

Transfer – AVI settings ► P223

- To export a playlist, tap the [Playlist] tab. From the [File format after export:] list, select a post-convert format and then tap [OK].

Transfer – Playlist settings ► P229

4 In the export dialog box, tap [Select Export Folder].

5 Tap [FTP Server], select the FTP server of T2 (destination), and then tap [OK].

6 Tap [Start].

Export starts. You can check the progress in the transfer screen.

Checking the transfer status►P59

Uploading files to T2/downloading files from T2

You can use FTP server to connect devices or edit terminals to your T2 and upload/download files.

NOTE

- For the following format files, only single files can be uploaded/downloaded.
 - XDCAM: MXF file
 - XDCAM EX: *.mp4 file
 - XAVC: MXF file
 - XAVC S: MP4 file
 - P2 AVC-ULTRA: MXF (OP-1a, OP-Atom) file
- When uploading files to T2 via FTP, if [File format after import:] is set to [AVI (HQX)] for the transfer setting of each format, the files will be converted to Grass Valley HQX AVI after uploaded.

Transfer settings►P219

- If you want to use Japanese for file names, you must set the character set of file names to UTF-8 on the FTP client side beforehand. Correct file names cannot be displayed if the character sets do not match. The configuration method depends on your software. Refer to the help etc.

1 Tap [Config].

You can operate it from the bin view, 1ch view, 3ch view, and transfer screen.

2 Tap [General], and then tap the [Network-1] tab or [Network-2] tab.

3 Configure the IP address and DNS server address.

General – Network-1/Network-2 settings►P194

4 Tap the [FTP] tab.

5 Tap [Settings...].

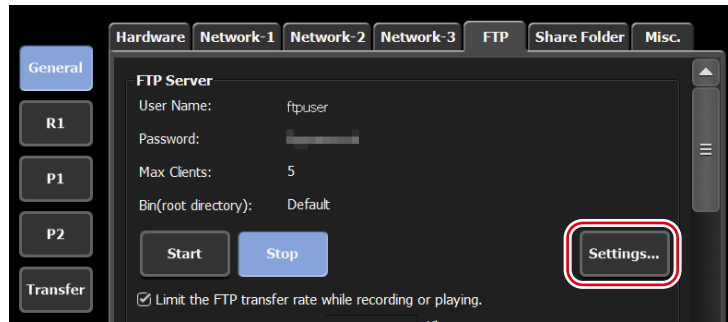

The dialog box for FTP setting of T2 appears.

FTP setting dialog box for T2 ▶ P198

6 Configure the FTP server settings of T2, and then tap [OK].

7 Tap [Start].

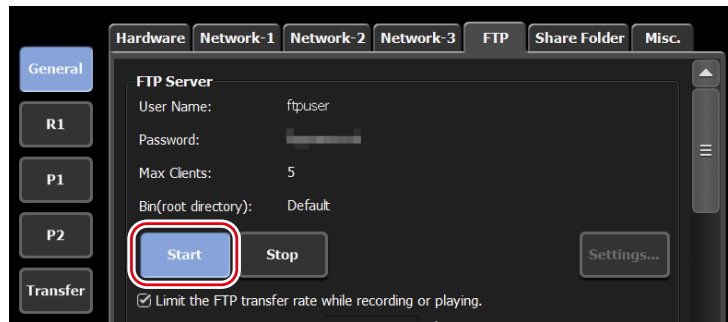

8 Tap [OK].

9 Access your T2 from a client.

Enter the IP address you configured in [Network-1] or [Network-2] and the user name and password you configured in the dialog box for FTP setting of T2, and connect to your T2 via FTP.

10 Upload or download file.

NOTE

- When using the FTP client where disconnection cannot be made explicitly such as Windows Explore, connection may be terminated due to the restriction of the simultaneous connection of clients. In such a case, tap [General] -> the [FTP] tab on the setup screen, and tap [Stop], and then tap [Start] again.
[FTP] tab ▶ P197

- NOTE**
- Depending on the FTP client, files may be transferred with multiple connections simultaneously. When using such an FTP client, make sure that the simultaneous connection of clients does not exceed the [Max Clients:] value set in the FTP setting dialog box of T2.

FTP setting dialog box for T2▶P198

- By default, the system will pause any transfer and conversion during a recording or playback. If you want transfer and conversion to be performed even during a recording or playback, change the setting by [Transfer] -> [Common] on the setting screen. Unchecking [Pause file transfers while recording or playing out.] enables transfer and conversion even during a recording or playback. However, if this option is unchecked, the recording/playback operations may not be performed normally, therefore, we recommend that you use the system with this option checked.

Transfer – common settings▶P219

Loading and editing T2 contents to editing software

You can load T2 contents to Grass Valley EDIUS, Adobe Premiere Pro, Apple Final Cut Pro and Avid Technology Media Composer to edit the data.

- NOTE**
- If you want to use Japanese for file names, you must set the character set of file names to UTF-8 on the FTP client side beforehand. Correct file names cannot be displayed if the character sets do not match. The configuration method depends on your software. Refer to the help etc.
 - Grass Valley EDIUS is recommended for the editing software.

- TIP**
- Markers set on T2 clips can be used on EDIUS.
Setting marker▶P122

Downloading and loading a recorded clip

Clips in the bin can be converted to different formats such as MXF (XDCAM format) and the converted clips can be downloaded from a client via FTP.

Notes on FTP download and growing clip editing▶P261

Transfer – AVI settings▶P223

- 1 Perform steps 1 to 8 in “Uploading files to T2/downloading files from T2”.

Uploading files to T2/downloading files from T2▶P69

2 Display the contents in the [Bin] tab.

Displaying the [Bin] tab►P76

3 Select an item, tap [Menu], and then tap [Convert] -> [Convert to (Format after conversion)].

POINT • To set the format for conversion, go to the setting screen, select [Transfer] -> [AVI], and configure the settings in [Advanced AVI transcoding settings].

Transfer – AVI settings►P223

4 Tap [Yes].

The conversion starts. You can check the progress in the transfer screen. The new converted clips will be saved in the same bin as their original ones.

Checking the transfer status►P59

5 Download the converted clip(s) via FTP from a client PC.

6 Load the downloaded clips to the editing software on the client PC.

Downloading and loading a growing clip

Clips can be ingested to MXF format and the growing clips can be downloaded from a client via FTP.

Notes on export and growing clip editing►P260

Notes on record of external device and growing clip editing►P261

Notes on FTP download and growing clip editing►P261

NOTE • Grass Valley EDIUS is recommended for the editing software.

1 Perform steps 1 to 8 in “Uploading files to T2/downloading files from T2”.

Uploading files to T2/downloading files from T2►P69

2 Tap [Config.].

3 Tap [R1] and set the compression codec to [(Recorded format)].

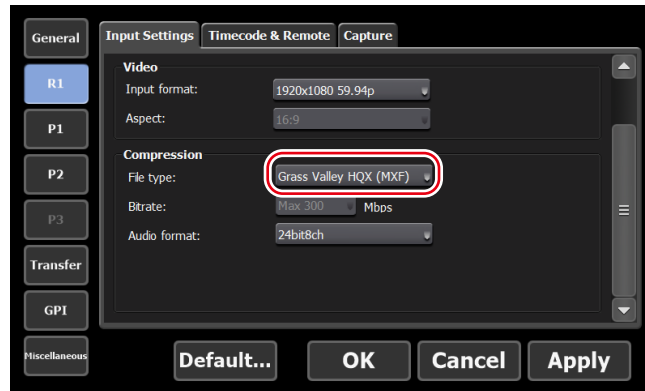

4 Tap [OK].

5 A message appears. Tap [OK].

A clip being recorded will become available to download on FTP.

6 Start recording.

7 Download the clip being recorded via FTP from a client PC.

8 Load the downloaded clips to the editing software on the client PC.

The clip being recorded can be viewed on K2 (FTP) in the EDIUS source browser. For the setting procedure of the source browser, refer to the EDIUS manual.

Directly loading a clip recorded or being recorded (T2 4K Elite/T2 4K Elite Plus only)

For T2 4K Elite/T2 4K Elite Plus, you can access the direct access folder (the media folder in T2 4K Elite/T2 4K Elite Plus) from the client to load clips recorded or being recorded.

NOTE

- Only available for T2 4K Elite/T2 4K Elite Plus.
- Grass Valley EDIUS is recommended for the editing software.
- Only AVI and MXF format media files can be accessed.
- The direct access folder is read-only. Moving and deleting of media files on the direct access folder cannot be performed from a client. To import media files from a client, use WatchFolder, FTP, etc.

Importing a media file on WatchFolder ▶ P61
Uploading files to T2/downloading files from T2 ▶ P69
General – Share Folder settings ▶ P199

1 Perform steps 1 to 3 in “Uploading files to T2/downloading files from T2”.

Uploading files to T2/downloading files from T2 ▶ P69

2 Tap [Config.] and then tap [Share Folder] tab.

3 Tap [Share a T2 media storage as share folder] in the direct access folder to check it..

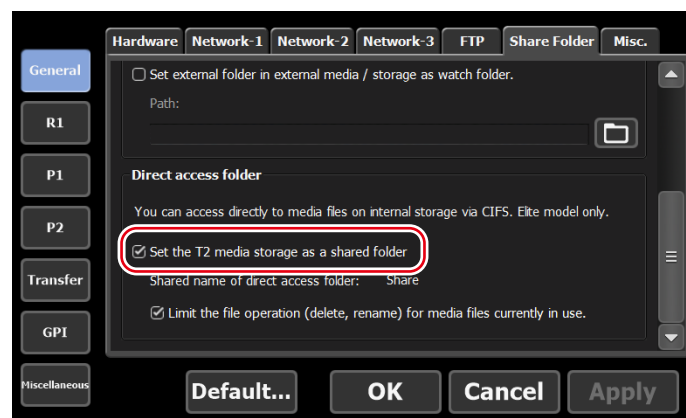

4 Tap [OK].

To enable the direct access folder setting, you must restart your T2.

5 Access T2 from a client PC and load a clip.

Access the address set as [Network-1] or [Network-2] from the client. The media folders are located under the Share folder of T2, and include the Default folder and a folder with the same name as the created bin.

NOTE

- A clip with which a sub clip has been created between In-Out points is loaded as the original clip that does not have In-Out points.

Creating a sub clip between In-Out points (highlight) ► P109

- The user account used to access the direct access folder can be set in [General] -> [Share Folder] in the setting screen.

General – Share Folder settings ► P199

Contents Management

This section describes the operations for contents management using the bin.

Managing contents in the bin

Displaying the [Bin] tab

In the [Bin] tab, you can manage the contents loaded to T2 and export contents edited with T2.

- 1 Tap [Bin].

The bin view appears.

- 2 Tap the [Bin] tab.

➤ [Bin] tab

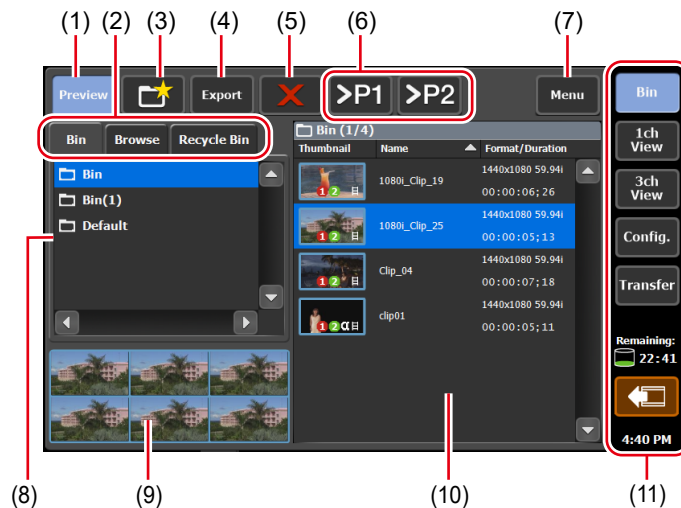

(1)	[Preview]	Switches on/off of the preview (filmstrip).
(2)	View switching tab	Switches between [Bin] tab/[Browse] tab/[Recycle Bin] tab.
(3)	[New Bin]	Creates a new bin.

(4)	[Export]	Exports the selected contents.
(5)	[Delete]	Deletes the selected contents.
(6)	[>Px]	Loads the selected contents to the Player channel.
(7)	[Menu]	Displays the related menu.
(8)	Bin list	Displays the list of bins. The selected bin is highlighted in blue.
(9)	Filmstrip display	By tapping [Preview] and set it on, displays the contents in filmstrip with six frames.
(10)	Contents list	Displays the list of contents selected in the bin list. The selected item is highlighted in blue.
(11)	1ch view/3ch view/ bin/transfer screen common area	1ch view/3ch view/bin/transfer screen common area▶P44

TIP • The IO modes available on your T2 differ depending on the T2 model type.
IO mode list▶P263

Changing bin name

You can change the name of the bin.

1 Select a bin in the [Bin] tab.

Displaying the [Bin] tab▶P76

2 Tap [Menu], and then tap [Rename Folder].

3 Enter a name for the bin and tap [OK].

Software keyboard▶P130

Deleting a bin

You can delete a bin and the contents in the bin. The deleted bins are moved to the recycle bin.

- 1 Select a bin in the [Bin] tab.

Displaying the [Bin] tab ► P76

- 2 Tap [Menu], and then tap [Delete Folder].

A message appears and the list of contents in the bin is displayed.

- 3 Tap [Yes].

Contents types and icons

The icons that indicate the contents types and common icons, and icons displayed regardless of the contents types are described in this section.

➤ Video clip



➤ Still image clip



➤ Playlist



➤ **Common icons**



(1)	Pairing	Indicates that pairing is set.
(2)	Used in playlist	Indicates that the content is used in the playlist.
(3)	Lock	Indicates that the item is locked.
(4)	Available number of times of recording	Indicates the number of video that can be recorded on the Recorder channel at the same time.
(5)	Available number of times of simultaneous playing	Indicates the number of contents that can be played back on the Player channels at the same time.
(6)	Containing alpha channel	Indicates that the contents have transparency information.
(7)	Recording	Indicates that the contents is being recorded. The sub clip of recording contents is not shown this icon.

Moving contents to another bin

You can move the contents in the bin to another bin.

1 Select the bin in the [Bin] tab and display the contents.

Displaying the [Bin] tab ▶ P76

2 Select an item, tap [Menu], and then tap [Move].

- 3 Select the destination bin and tap [OK].

Changing the display of contents list

You can switch the display of the contents list between icon display and text display.

- 1 Tap [Menu], and then tap [View].
- 2 Tap [Icon View] or [Text View].

Checking the properties of the contents

The procedure to check the properties of the clips or playlists in the bin is described in this part.

- 1 Select the bin in the [Bin] tab and display the contents.

Displaying the [Bin] tab ► P76

- 2 Select an item, tap [Menu], and then tap [Properties].

The properties of contents are displayed.

► Clip properties

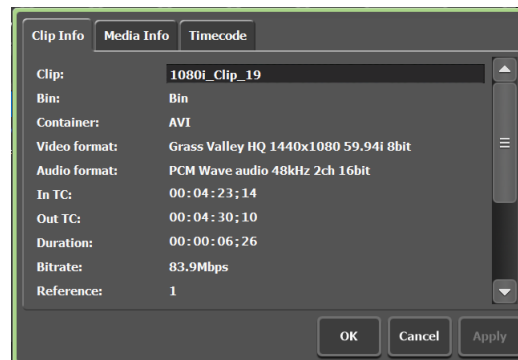

[Clip Info] tab

Displays the clip information.

You can check the clip name, format, In/Out points timecode, length, alpha channel presence, date of creation, bitrate, etc.

Tapping the entry area allows to change the clip name and audio gain. (For still images, the length can be changed.)

Checking [Locked] locks the clip from editing.

<p>[Media Info] tab</p>	<p>The information of media file is displayed. You can check the file path, clips referenced to the media file, and the number of reference clips, size, In/Out points timecode, etc. Tapping [Details...] displays the list of clips referenced to the media file and the number of reference clips.</p>
<p>[Timecode] tab</p>	<p>Specifies start timecode. To use the start timecode of a media file, select [Source]. To specify a start timecode, select [Specify Start Time], tap the entry area, and enter timecode.</p>

➤ **Playlist properties**

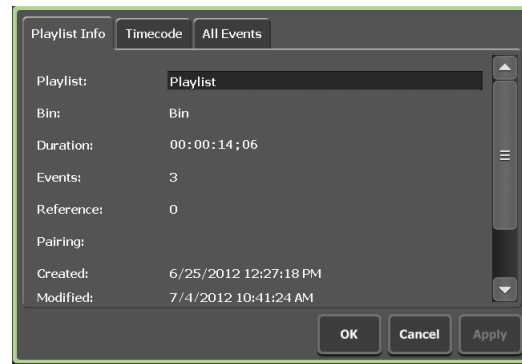

<p>[Playlist Info] tab</p>	<p>Displays the playlist information. You can check the playlist name, bin name where the playlist is stored, format, length, alpha channel presence, date of creation, etc. Tapping the entry area allows to change the playlist name and audio gain. Checking [Locked] locks the playlist from editing. To change the playlist type, switch to the workstation mode, and then change it. Changing the playlist type ► P180</p>
-----------------------------------	--

<p>[Timecode] tab</p>	<p>Specifies start timecode.</p> <p>[Source] Uses the start timecode of the media file.</p> <p>[Specify Start Time] Specifies a desired start timecode. Tap the entry area and enter a desired timecode.</p> <p>[According to event setting] Uses the timecode set in each event in the playlist.</p>
<p>[All Events] tab</p>	<p>Updates the settings of effect for event starting (start effects) and actions or effects for event ending (end effects) of all events in the playlist.</p> <p>Updating playlist effect settings ► P116</p>

3 Tap [OK].

Releasing pairing of contents

You can release the pairing of contents.

For pairing of contents, refer to “Sync playback of contents (Sync mode)”.

Sync playback of contents (Sync mode) ► P101

1 Select the bin in the [Bin] tab and display the contents.

Displaying the [Bin] tab ► P76

2 Select an item, tap [Menu], and then tap [Unpairing].

Converting contents to other formats

You can convert contents to other formats.

A playlist can be converted to a single clip (media file).

NOTE • If a playlist is converted to a single clip, the effect set to the playlist is disabled.

TIP

- You can convert Grass Valley HQX AVI files to some specific formats.

Transfer – AVI settings ► P223

- Playlists are converted with the following features.
 - If several formats are contained, they are converted in one file.
 - A timecode set in a playlist or event properties can be retained in each frame of the converted file.
 - When exporting files in Grass Valley HQX AVI format, the profile (size and frame rate) of the converted file is same as the profile of the playlist.
 - When exporting files in MXF or MOV format, files are converted according to the settings of [Advanced AVI transcoding settings] in [Transfer] -> [AVI] on the setting screen.
 - When converting playlists to export, files are converted according to the settings of [Advanced AVI transcoding settings] in [Transfer] -> [AVI] on the setting screen.

Transfer – AVI settings ► P223

- The audio gain set for the event in the playlist is maintained in the converted clip.
- Audio is converted into PCM 48kHz 24bit 8ch.
- You cannot convert a playlist that includes a place holder event.

1 Select the bin in the [Bin] tab and display the contents.

Displaying the [Bin] tab ► P76

2 Select an item, tap [Menu], and then tap [Convert] -> [Convert to (converted format)].

3 Tap [Yes].

The conversion starts.

The new converted clips will be saved in the same bin as their original ones.

You can check the progress in the transfer screen.

Checking the transfer status ► P59

NOTE • By default, the system will pause any transfer and conversion during a recording or playback. If you want transfer and conversion to be performed even during a recording or playback, change the setting by [Transfer] -> [Common] on the setting screen. Unchecking [Pause file transfers while recording or playing out.] enables transfer and conversion even during a recording or playback. However, if this option is unchecked, the recording/playback operations may not be performed normally, therefore, we recommend that you use the system with this option checked.
Transfer – common settings ► P219

Checking the recycle bin

Displaying the [Recycle Bin] tab

In the [Recycle Bin] tab, you can restore the deleted contents and completely delete the files in the recycle bin.

1 Tap [Bin].

The bin view appears.

2 Tap the [Recycle Bin] tab.

► [Recycle Bin] tab

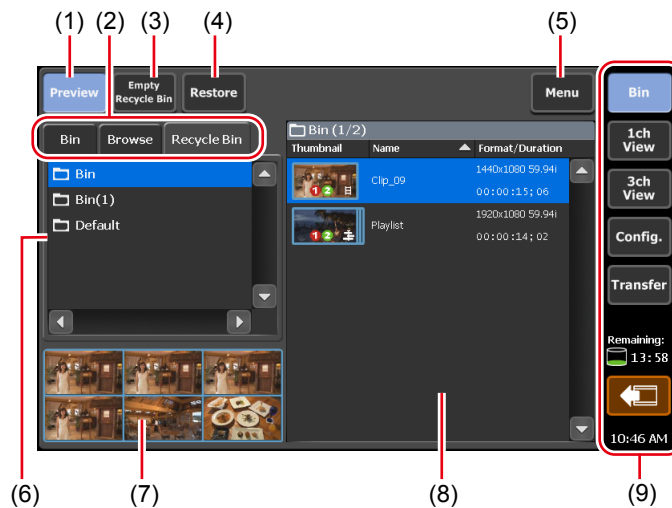

(1)	[Preview]	Switches on/off of the preview (filmstrip).
(2)	View switching tab	Switches between [Bin] tab/[Browse] tab/[Recycle Bin] tab.

(3)	[Empty Recycle Bin]	Deletes all files in the recycle bin. Note that the deleted contents cannot be restored.
(4)	[Restore]	Restores contents to the original bin. When restoring a playlist, if clips linked to the playlist are also in the recycle bin, the clips are restored at the same time.
(5)	[Menu]	Displays the related menu.
(6)	Recycle bin folder list	Displays the list of folders in the recycle bin.
(7)	Filmstrip display	By tapping [Preview] and set it on, displays the contents in filmstrip with six frames.
(8)	Contents list	Displays the list of contents in the folder selected in the recycle bin folder list.
(9)	1ch view/3ch view/bin/transfer screen common area	1ch view/3ch view/bin/transfer screen common area▶P44

Backing up all data to other T2 (full sync backup)

Overview of full sync backup function

T2 data (media files and database) can be synchronized to other (multiple) T2 on the network. T2 (slave) data on the sync destination is initialized and they are completely synchronized to T2 (master) data.

To synchronize data, set the sync destination T2 (slave) to the slave mode (step 1), and then set the sync source T2 (master) to the master mode. (step 2)

Step 1: Setting T2 on the sync destination to the slave mode

NOTE

- Set the remote mode to off on both T2 (master and slave) beforehand. (You cannot switch the remote mode to on and off while transferring files.)
- Synchronization is not available between T2 devices that have different database versions. Database version will be changed by such an event as software update.

1 On the sync destination T2, tap [Bin] or [1ch View].

- 2 Tap [Menu], and then tap [Tools] -> [T2 to T2 Sync backup...].

If contents are being captured or loaded in the Recorder channel or the Player channel, a message appears asking whether to unload the contents. Tap [OK] to unload the clip.

- 3 In [Operating mode] on the [T2 to T2 Sync backup] dialog box, select [Slave mode].

Do not close the [T2 to T2 Sync backup] dialog box until the backup operation completes.

T2 on the sync destination (slave) is set to the slave mode.

To sync data to multiple T2 (slave), repeat steps 1 to 3 on all of the T2 (slave).

Step 2: Setting T2 on the sync source to the master mode for data sync

- 1 On the sync source T2, tap [Bin] or [1ch View].

- 2 Tap [Menu], and then tap [Tools] -> [T2 to T2 Sync backup...].

If contents are being captured or loaded in the Recorder channel or the Player channel, a message appears asking whether to unload the contents. Tap [OK] to unload the clip.

- 3 In [Operating mode] on the [T2 to T2 Sync backup] dialog box, select [Master mode] and tap [Slave configuration...].

T2 on the sync source (master) is set to the master mode.

The number of T2 set to the slave mode is displayed in [Slave count:].

- 4 In the [Slave configuration...] dialog box, set the IP address of T2 set to the slave mode.

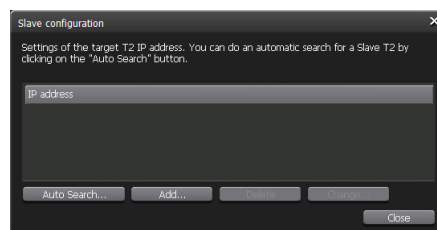

- Tap [Auto Search...] to search for T2 set to the slave mode on the network. Select an IP address on the [Search Results] dialog box, and then tap [Add ALL].
- To set an IP address manually, tap [Add] and enter an IP address.

- 5 Tap [Close].

- 6 In the [T2 to T2 Sync backup] dialog box, tap [Start Sync].

7 A message appears. Tap [OK].

The synchronization starts. You can check the file transfer status on the upper progress bar, and the whole status on the lower progress bar.

If you stop synchronization in the middle, tap [Stop]. You can also stop synchronization from T2 set to the slave mode.

8 After the synchronization has completed, click [Close] on the [T2 to T2 Sync backup] dialog box.

TIP

- If data synchronization has been stopped forcibly by such an event as the power off of T2, contents may be displayed with the following thumbnail. Such contents cannot be used.



- If synchronization has been stopped and started again, files that are already transferred will be skipped.

Playing/Editing

This section describes operations to play contents in the Player channel and to edit playlists.

Displaying Player channel in 1ch view

In the 1ch view of the Player channel, you can perform operations regarding contents editing.

1 Press the [P1] button (or [P2] button).

The display switches to the 1ch view of the Player channel and the [P1] button (or [P2] button) lights in green.

You can also switch by tapping [1ch View] and then tapping the Player channel tab.

If the clip is loaded to the Player channel, clip view is displayed. And if a playlist is loaded, playlist view is displayed.

You can use the operation buttons and jog/shuttle on the lower part of the touch screen LCD, to play or to switch playback modes.

➤ Player channel (clip view) – 1ch view

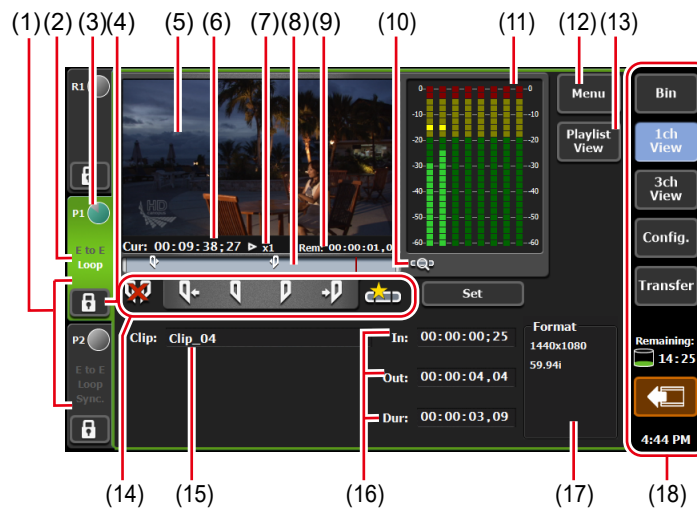

* (2) to (18) are common in P2 channel.

(1)	Player channel tab	By tapping, selects and highlights the Player channel.
(2)	Playback mode	Indicates the current playback mode (sync mode, E to E mode, loop playback mode) of the Player channel in white characters. While the Recorder channel is played back in E to E mode, the E to E indication is shown in blue text. By tapping, also switches the playback mode. Switching playback mode►P100
(3)	Status	Indicates the playback progress status.
(4)	[Locked]	Locks Player channel operations. While the operations are locked, [Locked] and [P1] (or [P2] button) buttons light in red. Tapping it again releases the lock.
(5)	Preview	Displays the video currently played back. Tapping the preview displays in the full screen view. If a clip is not loaded, displays the output profile of the channel on the upper left.
(6)	[Cur:]	Indicates the current timecode.
(7)	Playback speed	Indicates the current playback speed (times).
(8)	Scrubbing bar	Indicates the playback progress status and icons/markers for the set In/Out points.
(9)	[Rem:]	Indicates the timecode of the remaining time.
(10)	[Zoom]	Switches the display scale of the scrubbing bar. Tapping it displays [Zoom] in red, and displays the In-Out points of the clip as the whole scale. Tapping it again returns the display to the original scale and displays the whole clip.
(11)	Audio level display	Displays the audio playback level.
(12)	[Menu]	Displays the related menu.
(13)	[Playlist View]	Switches to the playlist view.

(14)	Operation buttons	Operation buttons of Player channel (clip view) ► P90
(15)	[Clip:]	Indicates the name of the loaded clip. Tapping the entry area allows to change the clip name. Software keyboard ► P130
(16)	[In:]/[Out:]/[Dur:]	Indicates the timecode of In/Out points and duration. Tapping the entry area allows to set the In and Out points or duration. Software keypad – Timecode ► P131
(17)	[Format:]	Indicates the video size of the clip and frame rate.
(18)	1ch view/3ch view/bin/transfer screen common area	1ch view/3ch view/bin/transfer screen common area ► P44

➤ **Operation buttons of Player channel (clip view)**

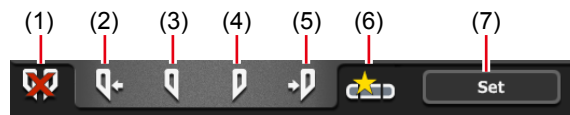

(1)	[Clear (In/Out)]	Clears In/Out points set on the clip.
(2)	[Cue(In)]	Moves to the In point of the clip.
(3)	[Mark(In)]	Sets In point to the current position. After In point has been set, the In point icon appears on the scrubbing bar.
(4)	[Mark(Out)]	Sets Out point to the current position. After Out point has been set, the Out point icon appears on the scrubbing bar.
(5)	[Cue(Out)]	Moves to the Out point of the clip.
(6)	[Create Subclip]	Creates a sub clip between the set In-Out points. Creating a sub clip between In-Out points (highlight) ► P109

(7)	[Set]	Trims the clip between the set In-Out points. Trimming a clip between the set In-Out points►P108
-----	-------	--

► Player channel (playlist view) – 1ch view

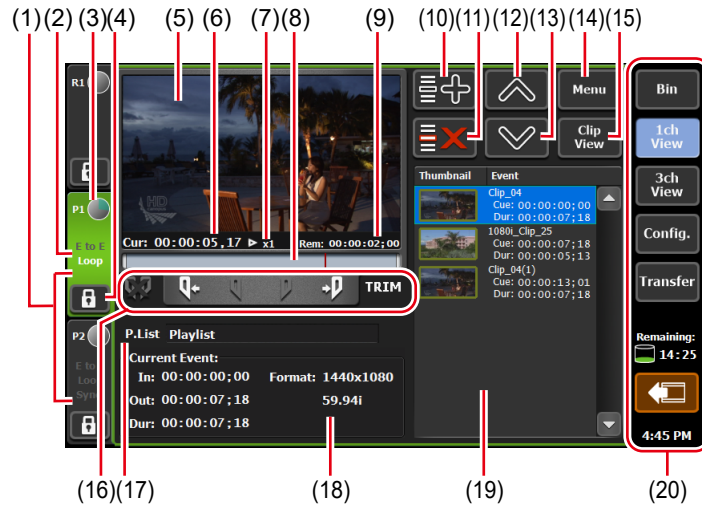

* (2) to (20) are common in P2 channel.

(1)	Player channel tab	By tapping, selects and highlights the Player channel.
(2)	Playback mode	Indicates the current playback mode (sync mode, E to E mode, loop playback mode) in white characters. While the Recorder channel is played back in E to E mode, the E to E indication is shown in blue text. By tapping, also switches the playback mode. Switching playback mode►P100
(3)	Status	Indicates the playback progress status.
(4)	[Locked]	Locks Player channel operations. While the operations are locked, [Locked] and [P1] (or [P2] button) buttons light in red. Tapping it again releases the lock.

(5)	Preview	Displays the video currently mounted. Tapping the preview displays in the full screen view. If a playlist is not loaded, displays the output profile of the channel on the upper left.
(6)	[Cur:]	Indicates the current timecode of the playlist.
(7)	Playback speed	Indicates the current playback speed (times).
(8)	Scrubbing bar	Indicates the playback progress status and icons/markers for the set In/Out points.
(9)	[Rem:]	Indicates the timecode for the remaining time of event.
(10)	[Add Event]	Adds an event to the playlist. Creating a playlist▶ P110
(11)	[Delete Event]	Deletes the event selected in the event list.
(12)	[Move Up]	Moves up the event selected in the event list.
(13)	[Move Down]	Moves down the event selected in the event list.
(14)	[Menu]	Displays the related menu.
(15)	[Clip View]	Switches to the clip view.
(16)	Operation buttons	Operation buttons of Player channel (playlist view)▶ P93
(17)	[P.List] / [T.Line]	Indicates the name of the loaded playlist. Tapping the entry area allows to change the playlist name. Software keyboard▶ P130 [P.List] Playlist in the normal format. [T.Line] Playlist in the timeline format. Changing the playlist type▶ P180

(18)	[Current Event:]	<p>Displays the information of the event being played.</p> <p>[In:]/[Out:]/[Dur:] Indicates the timecode of In/Out points and the length of the event (duration).</p> <p>[Format:] Indicates the video size and frame rate.</p>
(19)	Event list	<p>Displays the list of events in the playlist. The selected event is displayed with a blue frame.</p> <p>The event being played is highlighted in blue.</p>
(20)	1ch view/3ch view/bin/transfer screen common area	1ch view/3ch view/bin/transfer screen common area ▶ P44

➤ **Operation buttons of Player channel (playlist view)**

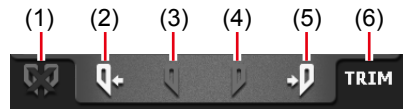

(1)	[Clear (In/Out)]	In the TRIM mode, clears In/Out points set on the event to cancel the TRIM mode.
(2)	[Cue(In)]	Moves to the In point of the event.
(3)	[Mark(In)]	In the TRIM mode, sets In point to the current position. After In point has been set, the In point icon appears on the scrubbing bar.
(4)	[Mark(Out)]	In the TRIM mode, sets Out point to the current position. After Out point has been set, the Out point icon appears on the scrubbing bar.
(5)	[Cue(Out)]	Moves to the Out point of the event.
(6)	[TRIM]	<p>Switches to the TRIM mode. You can edit the In/Out points of the event selected in the event list.</p> <p>Trimming an event ▶ P113</p>

Selecting Player channel in 3ch view

When [[HD/SD] 1 in 2 out] is selected in 3ch view, you can view the R1, P1, and P2 channels simultaneously.

In 3ch view of Player channel, you can use the operation buttons and jog/shuttle on the lower part of the touch screen LCD, to play or to switch playback modes.

1 Tap [3ch View].

The display switches to 3ch view.

2 Tap the Player channel tab.

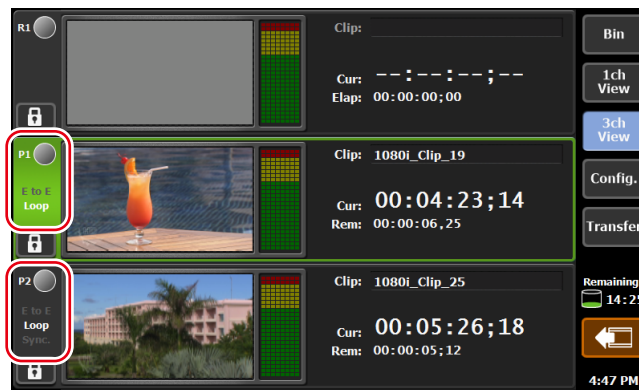

Player channel is selected and highlighted. The playback operation to the selected channel becomes valid.

If the clip is loaded to the Player channel, clip view is displayed. And if a playlist is loaded, playlist view is displayed.

➤ Player channel (clip view) – 3ch view

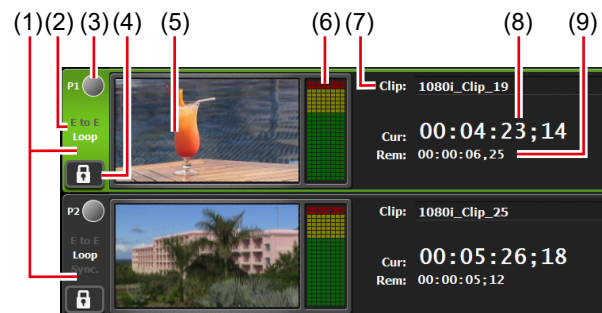

* (2) to (9) are common in P2 channel.

(1)	Player channel tab	By tapping, selects and highlights the Player channel.
------------	---------------------------	--

(2)	Playback mode	Indicates the current playback mode (sync mode, E to E mode, loop playback mode) of the Player channel in white characters. While the Recorder channel is played back in E to E mode, the E to E indication is shown in blue text. By tapping, also switches the playback mode. Switching playback mode►P100
(3)	Status	Indicates the playback progress status.
(4)	[Locked]	Locks Player channel operations. While the operations are locked, [Locked] and [P1] (or [P2] button) buttons light in red. Tapping it again releases the lock.
(5)	Preview	Displays the video currently played back. If a clip is not loaded, displays the output profile of the channel on the upper left.
(6)	Audio level display	Displays the audio playback level.
(7)	[Clip:]	Indicates the name of the loaded clip. Tapping the entry area allows to change the clip name. Software keyboard►P130
(8)	[Cur:]	Indicates the current timecode.
(9)	[Rem:]	Indicates the timecode of the remaining time.

► **Player channel (playlist view) – 3ch view**



* (2) to (11) are common in P2 channel.

(1)	Player channel tab	By tapping, selects and highlights the Player channel.
-----	---------------------------	--

(2)	Playback mode	<p>Indicates the current playback mode (sync mode, E to E mode, loop playback mode) of the Player channel in white characters.</p> <p>While the Recorder channel is played back in E to E mode, the E to E indication is shown in blue text.</p> <p>By tapping, also switches the playback mode.</p> <p>Switching playback mode►P100</p>
(3)	Status	<p>Indicates the playback progress status.</p>
(4)	[Locked]	<p>Locks Player channel operations.</p> <p>While the operations are locked, [Locked] and [P1] (or [P2] button) buttons light in red.</p> <p>Tapping it again releases the lock.</p>
(5)	Preview	<p>Displays the video currently played back.</p> <p>If a playlist is not loaded, displays the output profile of the channel on the upper left.</p>
(6)	Audio level display	<p>Displays the audio playback level.</p>
(7)	[P.List:]/[T.Line]	<p>Indicates the name of the loaded playlist.</p> <p>Tapping the entry area allows to change the playlist name.</p> <p>Software keyboard►P130</p> <p>[P.List]</p> <p>Indicates a playlist in the standard format.</p> <p>[T.Line]</p> <p>Indicates a playlist in the timeline format.</p> <p>Changing the playlist type►P180</p>
(8)	[Now:]	<p>Indicates the name of the current event.</p>
(9)	[Next:]	<p>Indicates the name of the next event.</p>
(10)	[Cur:]	<p>Indicates the current timecode of the playlist.</p>
(11)	[Rem:]	<p>Indicates the timecode of the remaining time of event.</p>

Loading contents to Player channel

The procedure to load the contents in the bin to the Player channel is described in this part.

Contents loaded to the Player channel can be performed playback or editing of In/Out points.

- 1 Select the bin in the [Bin] tab and display the contents.

Displaying the [Bin] tab ► P76

- 2 Select an item and tap [>Px].

The item is loaded to the Player channel.

If the clip is loaded to the Player channel, clip view is displayed. And if a playlist is loaded, playlist view is displayed.

Player channel (clip view) – 1ch view ► P88

Player channel (playlist view) – 1ch view ► P91

- TIP**
- To unload contents, display the Player channel in 1ch view, tap [Menu], and then tap [Unload].

Playing back video

Playing back with operation buttons

You can play the video of the selected channel using the operation buttons.

- 1 Press the [Play] button.

Control buttons ► P29

During the playback, the [Play] button lights up.

Playing back in variable speed mode (variable playback)

You can play the video of the selected channel in the variable speed mode.

- 1 Press the [VAR] button.

Control buttons ► P29

The mode switches to the variable speed mode and VAR speed control is displayed.

While in the variable speed mode, the [VAR] button lights up.

➤ **VAR speed control**

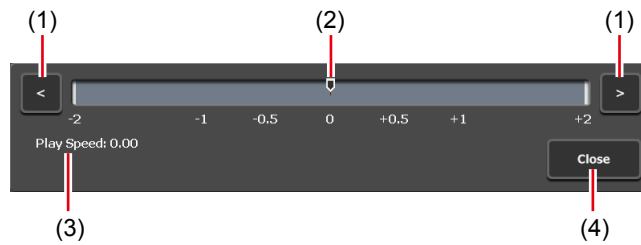

(1)	[<]/[>]	By every tap, increases or decreases the playback speed by 0.1 time.
(2)	Speed control bar	By tapping on the speed control bar, specifies the playback speed within the range of -2 to +2 times.
(3)	[Play Speed:]	Indicates the current playback speed.
(4)	[Close]	Closes the VAR speed control. Even after closing the VAR speed control, you can perform variable speed playback by operating the jog/shuttle.

2 Press the [Play] button.

3 Tap the speed control bar and move it.

Steps 2 and 3 can also be operated by the jog/shuttle.

Playing back in jog/shuttle mode

You can fast forward or rewind the video of the selected channel using jog/shuttle operations.

The playback speed changes by the operating angle of jog/shuttle.

1 Press the [SHTL/JOG] button.

Control buttons ▶ P29

The mode switches to the jog/shuttle mode and the [SHTL/JOG] button lights up.

2 Turn the jog/shuttle.

Turn to the right to fast forward, and turn to the left to rewind.

Depending on the angle to turn the jog/shuttle, the speed can be switched from 0.13 to 32 times (7 levels) for the right side, and from -0.13 to -32 times (7 levels) for the left side.

TIP • The maximum speed of the shuttle (16 times/32 times) can be changed.

Miscellaneous – Jog/Shuttle settings ▶ P233

Loading and playing back video currently recorded (chasing playback)

The video currently recorded in the Recorder channel can be loaded and played on the Player channel.

If you only want to load the currently recorded video and do not want to play it back, you do not need to perform steps 1 to 4.

NOTE • Chasing playback of video while being recorded is enabled only in the [[HD/SD] 1 in 2 out] mode.

1 Tap [Config.].

You can operate it from the bin view, 1ch view, 3ch view, and transfer screen.

2 Tap [P1] (or [P2]), and then tap [Video].

Player – Video settings ► P213

3 In [Auto play mode:], tap and check [Auto Play].

4 Tap [OK].

5 Press the [P1] button (or [P2] button).

6 Switch to the clip view.

If the playlist view is displayed, tap [Clip View] to switch the display.

7 Tap [Menu], and then tap [Now recording].

The video currently recorded in the Recorder channel are loaded to the Player channel and played back automatically.

TIP • Clicking the [Move to next edit point] button during chasing playback in the workstation mode moves the playback to the latest recording point.

Operation buttons of Player channel ► P156

Switching playback mode

Outputting currently recorded video with active through (E to E mode)

If the E to E mode is set to on in the Player channel, you can output video currently recorded in the Recorder channel to the Player channel with active through.

NOTE

- The video format of the Player channel set to the E to E mode and that of the Recorder channel must be the same.
Recorder – Input Settings►P207
Player – Video settings►P213
- E to E mode is only available while in the [[HD/SD] 1 in 2 out] mode.
- Prior setting is necessary. From the setting screen, go to [General] -> [Hardware] tab, and select [Input] for [Reference:].
General – Hardware settings►P189

- 1 Tap the Player channel tab.
- 2 Tap the playback mode, and then tap [E to E] from the menu.

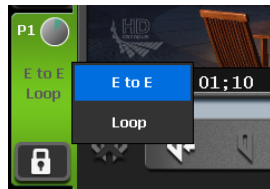

[E to E] in the menu is checked and [E to E] in the Player channel tab is displayed in white characters.

- 3 On the channel selected in step 1, stop the playback of contents or unload it.

The video currently recorded is output when the playback of contents has been stopped or loading of contents is not executed.

While the video currently recorded is being output, the [E to E] indication on the Player's channel tab is shown in blue text.

TIP

- You can also perform the same operation by tapping [Menu] in the 1ch view of Player channel, and then tapping [Playout Mode] -> [E to E].

Loop playback of contents (Loop mode)

If the Loop mode is set to on in the Player channel, you can perform loop playback of the contents played on the Player channel.

- 1 Tap the Player channel tab.
- 2 Tap the playback mode, and then tap [Loop] from the menu.



[Loop] in the menu is checked and [Loop] in the Player channel is displayed in white characters.

- TIP**
- You can also perform the same operation by tapping [Menu] in the 1ch view of Player channel, and then tapping [Playout Mode] -> [Loop].

- 3 Play the contents selected in step 1.

Sync playback of contents (Sync mode)

By pairing two contents and setting sync mode to on, the playback status of the two contents can be synchronized.

You can use this function in such cases as when you want to synchronize and play the L side and R side of a video.

- NOTE**
- Sync mode is only enabled when the combination of P1/P2 channels is used.
 - Media files in the removable media cannot be paired.
 - A combination of playlist and clip cannot be paired.
 - The E to E mode and sync mode cannot be set to on at the same time.
 - In sync mode, only the following operations are available.
 - Normal or variable speed playback
 - Stopping playback
 - Forwarding/rewinding frame by frame
 - Moving to an In/Out point
 - Setting markers, moving to markers

- 1 Load contents to the P1 channel.

Loading contents to Player channel ► P97

- 2 Load the contents to be synchronized with the contents loaded in step 1 to P2 channel.
- 3 Tap the P2 channel tab.
- 4 Tap the playback mode, and then tap [Sync] from the menu.



[Sync] in the menu is checked and [Sync.] in the P2 channel tab is displayed in white characters.

TIP

- You can also perform the same operation by tapping [Menu] in the 1ch view of P2 channel, and then tapping [Playout Mode] -> [Sync].
- If the output settings of the P1 channel and P2 channel are different, the setting of the P2 channel will be automatically changed to be the same as that of the P1 channel.

- 5 A message appears. Tap [Yes].

The contents mounted on the P1 and P2 channels are paired.

- 6 Select the P1 channel and press the [Play] button.

Contents loaded on the P2 channel is played back, being synchronized with the contents loaded on the P1 channel.

TIP

- To release the pairing of contents, operate in the [Bin] tab.
Releasing pairing of contents ▶ P82

Playback of contents with alpha channel (Fill/Key signal output mode)

You can play contents with transparency information (alpha channel).

NOTE • Fill/Key signal output mode is only enabled when the combination of P1/P2 channels is used.

1 Load the contents with alpha channel to the Player channel.

Loading contents to Player channel ▶ P97

The mode switches to the Fill/Key signal output mode. Fill is output to the loaded channel, and Key is output to the other channel.

The icons indicating Fill and Key appear on the Player channel tabs respectively.

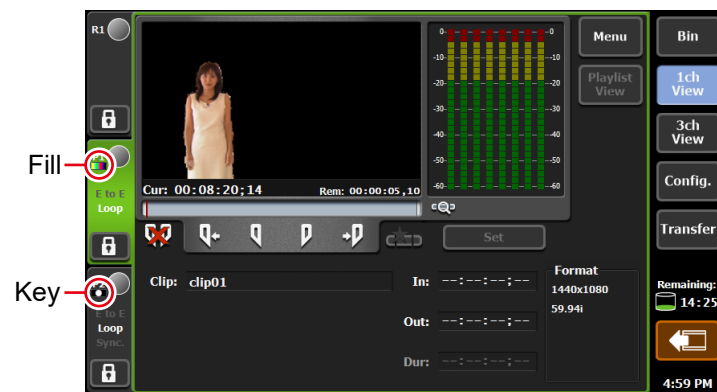

2 Play the contents on the channel where Fill is output.

Playback operations of clips with alpha channel can be performed only on the Fill side channel.

When you play a playlist that contains clips with alpha channel, the system enters the Fill/Key signal output mode and the Key side channel will output a white screen for normal clip playback.

TIP • If a clip with alpha channel is added to the playlist in the normal mode, the mode switches to the Fill/Key output mode after unmounting. The video may be disrupted due to the output signal loss when the modes are switched, however, this is not a system failure.

TIP

- The following operations are available while a clip with alpha channel is loaded.
 - Moving to an In/Out point
 - Setting an In/Out point
 - Creating a sub clip (you cannot create a sub clip of a still image clip with alpha channel)
 - Moving to the first frame, frame reverse, stop, playback, frame forward, moving to the last frame, fast forward, rewind, and variable speed playback
 - Scrubbing bar operation (workstation mode only)
 - Setting a fade in effect (applied to the Key side)/fade out effect (applied to the Key side)/actions (pause, loop) to an event in a playlist
 - Setting markers, moving to markers
- The following operations are not available while a clip with alpha channel is loaded.
 - Switching to the TRIM mode in the playlist view
- You can also play clips with alpha channel using the remote control with AMP commands.

Changing on-screen display indication

Showing on-screen display

Additional information (such as timecode and audio level meter) can be shown on Player channel preview of the T2 screen or on the output video from the SDI terminal.

1 Press the [P1] button (or [P2] button).

Select a Player channel to show on-screen display.

- 2 Tap [Menu], and then tap [On Screen Display] -> [Both] or [PC Preview only].

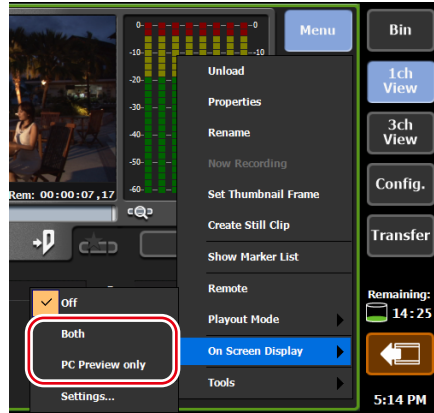

- Tapping [Both] shows on-screen display both on the Player channel preview of the T2 screen and on the output video from the SDI terminal.
- Tapping [PC Preview only] shows on-screen display only on the Player channel preview of the T2 screen.

Configuring display content of on-screen display

- 1 Press the [P1] button (or [P2] button).
- 2 Tap [Menu], and then tap [On Screen Display] -> [Settings...].

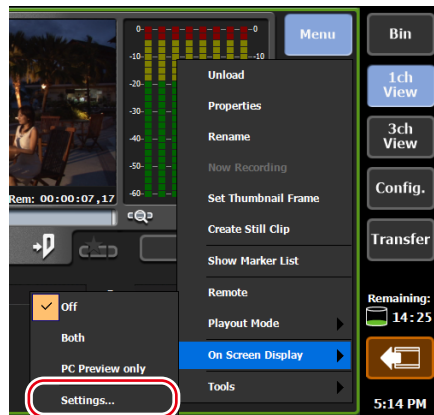

➤ On-screen display detailed settings dialog box

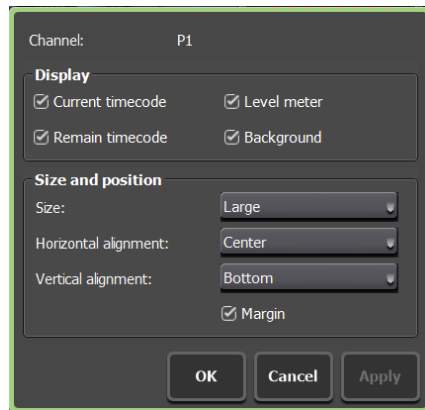

[Channel:]	Indicates the channel to be configured.
[Display]	<p>Sets items to show.</p> <p>[Current timecode] By checking, shows the current timecode.</p> <p>[Remain timecode] By checking, shows the timecode by remaining time.</p> <p>[Level meter] By checking, shows the audio playback level.</p> <p>[Background] By checking, shows background screen for on-screen display.</p>
[Size and position]	<p>Sets the position to show and text size.</p> <p>[Size:] Selects text size.</p> <p>[Horizontal alignment] Selects horizontal position for display.</p> <p>[Vertical alignment] Selects vertical position for display.</p> <p>[Margin] By checking, shows on-screen display slightly inside from the screen edge.</p>

3 Set display indication contents and tap [OK].

Editing a clip

Setting In and Out points to a clip

You can set In and Out points to a clip.

If In and Out points have been set to a clip, you can move to the set In point or Out point, trim between In-Out points, or save it as a sub clip.

1 Load a clip to the Player channel.

Loading contents to Player channel ▶ P97

2 Play a clip and tap [Mark(In)] when you want to set the In point.

Operation buttons of Player channel (clip view) ▶ P90

The In point is set to the current position. A icon appears in the In point position on the scrubbing bar.



3 Play a clip and tap [Mark(Out)] when you want to set the Out point.

The Out point is set to the current position. A icon appears in the Out point position on the scrubbing bar.



TIP

- You can also specify In and Out points with the timecode. Tap the entry area of [In:] and [Out:], and enter the timecode.

Player channel (clip view) – 1ch view ▶ P88

Trimming a clip between the set In-Out points

If set In and Out points are fixed, you can trim a clip between the In/Out points.

1 Set In and Out points to a clip.

Setting In and Out points to a clip►P107

2 Tap [Set].

Operation buttons of Player channel (clip view)►P90

The information of the In-Out points for the clip is updated with the set In and Out points. The space between the In-Out points is displayed in a pale white bar.



- TIP**
- To change the trimmed video between In-Out points, set In and Out points to the clip again, and then tap [Set].

Creating a sub clip between In-Out points (highlight)

You can create a sub clip between set In-Out points and save it as a separate clip.

1 Set In and Out points to a clip.

Setting In and Out points to a clip►P107

2 Tap [Create Subclip].

Operation buttons of Player channel (clip view)►P90

A sub clip including video between the set In and Out points is created and saved in the same bin as the original clip.

Cutting out a still image clip

You can cut out the current position of the clip that is mounted on the Player channel as a still image clip.

1 Move to the position you wish to cut out as a still image.

2 Tap [Menu] in the clip view and then tap [Create Still Clip].

3 A still image clip is saved in the same bin as the clip being mounted.

The duration of the still image clip is applied according to the time period of seconds set for [Duration (still image)] in the [Common] tab of [Transfer] in the setting screen.

Transfer – common settings►P219

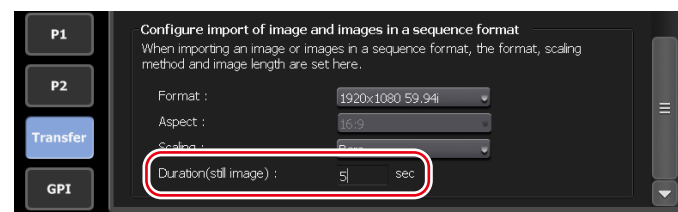

NOTE

- You cannot cut out still image clips from clips mounted directly from an external storage, etc.

TIP

- In the workstation mode, right-click on the preview window, and click [Create Still Clip].
- In the workstation mode, still image clips are stored in the selected bin.

Checking clip properties

You can check the properties of the clip loaded to the Player channel.

- 1 Tap [Menu] in the clip view, and then tap [Properties].

The properties of the clip are displayed.

Clip properties ► P80

Changing a clip name

You can change the name of the clip loaded to the Player channel.

- 1 Tap [Menu] in the clip view, and then tap [Rename].
- 2 Enter a name and tap [OK].

Software keyboard ► P130

Updating thumbnails of clips

You can update the thumbnail images of the clips displayed on the contents list in the bin view to the image of the current position.

- 1 Tap [Menu] in the clip view, and then tap [Set Thumbnail Frame].

Editing a playlist

Creating a playlist

You can create a playlist including multiple contents.

To create a playlist, add contents to the playlist view on the Player channel.

The contents added on the playlist are called event.

The procedure to create a new playlist is described in this part.

TIP

- You can add a playlist to another playlist as an event. The added playlist is called playlist event.
If you add a playlist which contains a playlist event to another playlist, a message appears. Select an adding method of a playlist event.
- Playlists includes normal format and timeline format playlists. In a playlist in the normal format, each events are added without creating spaces. In a playlist in the timeline format, events can be added to a desired position on the timeline by specifying the timecode.
- Creating or editing of a playlist in the timeline format can be performed only in the workstation mode.

Changing the playlist type ► P122

Editing playlist in the timeline format ► P182

1 Press the [P1] button (or [P2] button).

2 Switch to the playlist view.

If the clip view is displayed, tap [Playlist View] to switch the display.

3 Tap [Add Event].

Player channel (playlist view) – 1ch view ► P91

The dialog box to add an event appears.

TIP • To add contents to an existing playlist, select an event immediately before the position to add the contents and tap [Add Event].

4 Tap [Select Bin].

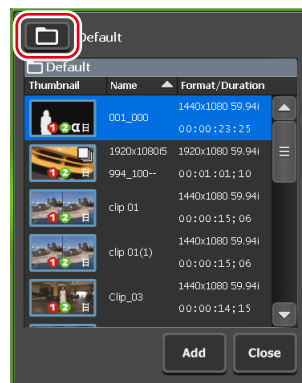

5 Select a bin that includes the contents to be added to the playlist and tap [OK].

6 Select contents in the dialog box to add an event and tap [Add].

7 Repeat steps 4 to 6.

8 Tap [Close].

The contents are registered as events in the playlist by the added order. Playlists are saved in the bin selected in step 5 with the name “Play (serial number)”.

Deleting an event from a playlist

You can delete an event from a playlist.

Even after events have been deleted from the playlist, the original contents will not be deleted.

- 1 Tap and select an event to delete in the playlist view.

The selected event is displayed with a blue frame.

- 2 Tap [Delete Event].

Player channel (playlist view) – 1ch view ▶ P91

Playing back a playlist

You can load a playlist to the Player channel and play it.

- 1 Load a playlist to the Player channel.

Loading contents to Player channel ▶ P97

When you load a playlist to the Player channel, the playback position automatically moves to the In point of the first event.

Double-tapping a desired event can move the playback position to the In point of the event.

- 2 Press the [Play] button.

Playing back video ▶ P97

The event being played is highlighted in blue.

Icons for events

The icons displayed in the thumbnails are described in this part.

➤ Event icons

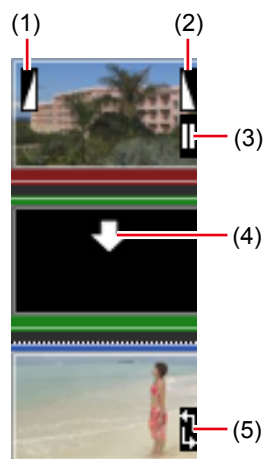

(1)	Fade in	Indicates that fade in is set.
-----	---------	--------------------------------

(2)	Fade out	Indicates that fade out is set.
(3)	Pause	Indicates that the playback stop operation of the event is set to pause.
(4)	Place holder	Indicates that a place holder is set. Adding place holder to playlist►P118
(5)	Loop playback	Indicates that loop playback is set.

Trimming an event

In the TRIM mode, you can trim an event by setting In and Out points to the event.

1 Double-tap and select an event to trim in the playlist view.

2 Tap [TRIM].

The mode switches to the TRIM mode.

3 Play an event and tap [Mark(In)] when you want to set the In point.

Operation buttons of Player channel (playlist view)►P93

The In point is set to the current position. A icon appears on the In point position on the scrubbing bar.



4 Play an event and tap [Mark(Out)] when you want to set the Out point.

The Out point is set to the current position. A icon appears on the Out point position on the status bar.



5 Tap [TRIM].

The TRIM mode exits, and the event is trimmed between the set In-Out points.

Setting effects on an event

You can set effects at the event start point (start effect) or the effect at the event end point (end effect).

1 Tap and select an event in the playlist view.

The selected event is displayed with a blue frame.

2 Tap [Menu], and then tap [Event Effect].

3 To set a start effect, tap the [Start Effect] tab and set each item.

➤ Event – [Start Effect] tab

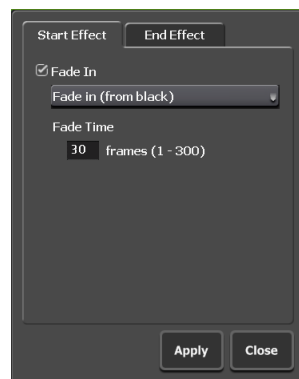

[Fade In]

To set a fade in effect, check [Fade In] and select an action from the list.

- [Fade in (from black)]
Sets a fade in effect from a black screen.
- [Fade in (from white)]
Sets a fade in effect from a white screen.

Tap the entry area of [Fade Time] and enter the number of frames from the start point to the end point.

4 To set an end effect, tap the [End Effect] tab and set each item.

➤ **Event – [End Effect] tab**

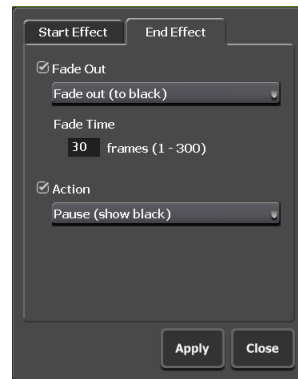

<p>[Fade Out]</p>	<p>To set a fade out effect, check [Fade Out] and select an action from the list.</p> <ul style="list-style-type: none"> • [Fade out (to black)] Sets a fade out effect to a black screen. • [Fade out (to white)] Sets a fade out effect to a white screen. <p>Tap the entry area of [Fade Time] and enter the number of frames from the start point to the end point.</p>
<p>[Action]</p>	<p>To set an end action for playback, check [Action] and select an action from the list.</p> <ul style="list-style-type: none"> • [Pause (show black)] Pauses the playback with a black screen displayed. • [Pause (show white)] Pauses the playback with a white screen displayed. • [Pause (show last frame)] Pauses the playback with the last frame displayed. • [Pause (show next event frame)] Pauses the playback with the first frame of the next event displayed. • [Pause (show E to E)] Displays the video currently input to the Recorder channel with active-through output. • [Loop] Plays back the event in loop.

5 Tap [Apply].

TIP • If you set the effects as an event template of playlist, the template setting is applied to newly added events.
General – Miscellaneous settings ▶ P202

Updating playlist effect settings

You can collectively set effects for event starting (start effects) and actions or effects for event ending (end effects) to all events in the playlist.

You can also collectively delete effects set to the events.

1 Display the playlist properties.

Checking playlist properties► P120

Checking the properties of the contents► P80

2 Tap the [All Events] tab.

► Playlist – [All Events] tab

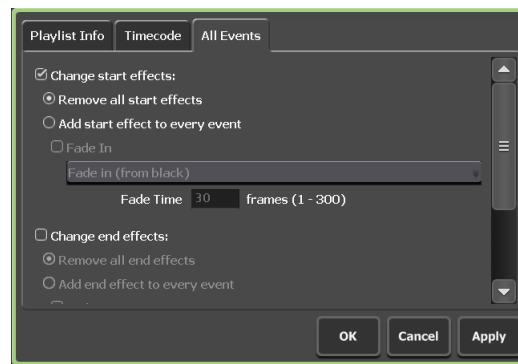

[Change start effects:]

Check it when you want to update the setting of start effects.

[Remove all start effects]

Deletes start effects set to the event.

[Add start effect to every event]

Updates start effects (fade in) set to the event.

To set a fade in effect, check [Fade In] and select an action from the list.

- [Fade in (from black)]
Sets a fade in effect from a black screen.
- [Fade in (from white)]
Sets a fade in effect from a white screen.

Tap the entry area of [Fade Time] and enter the number of frames from the start point to the end point.

[Change end effects:]	<p>Check it when you want to update the setting of end effects.</p> <p>[Remove all end effects] Deletes end effects set to the event.</p> <p>[Add end effect to every event] Updates the end effects (fade out or end action for playback) set to the event. To set a fade out effect, check [Fade Out] and select an action from the list.</p> <ul style="list-style-type: none"> • [Fade out (to black)] Sets a fade out effect to a black screen. • [Fade out (to white)] Sets a fade out effect to a white screen. <p>Tap the entry area of [Fade Time] and enter the number of frames from the start point to the end point. To set an end action for playback, check [Action] and select an action from the list.</p> <ul style="list-style-type: none"> • [Pause (show black)] Pauses the playback with a black screen displayed. • [Pause (show white)] Pauses the playback with a white screen displayed. • [Pause (last frame)] Pauses the playback with the last frame displayed. • [Pause (next event)] Pauses the playback with the first frame of the next event displayed. • [Pause (show E to E)] Displays the video currently input to the Recorder channel with active-through output. • [Loop] Plays back the event in loop.
------------------------------	---

3 Set each item and tap [OK].

Adding place holder to playlist

Place holder is the temporary event that can be replaced to a clip event later. The length of the event can be set as desired in event properties.

TIP • Adding and replacing a place holder event is available only in the workstation mode.

1 Right-click on a desired event and click [Placeholder] -> [Insert into] -> [Before] or [After].

A place holder is added before or after the event, and a down arrow icon is displayed on the place holder.

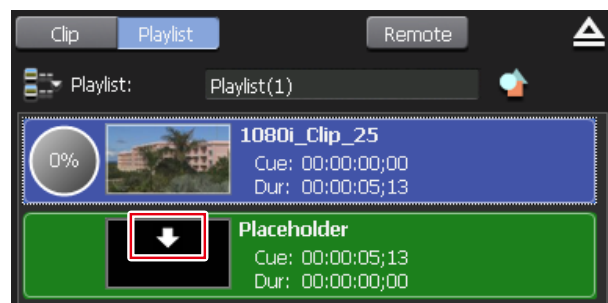

TIP • Alternatively, right-click on the playlist without selecting any event, and then click [Placeholder] -> [Insert at the tail], to add a place holder.

- Select [Placeholder] -> [Insert at the tail] from [Playlist Menu] to create a new playlist containing a place holder event.

Player channel (playlist view) – 2ch/3ch view ► P155

- You can make settings for adding a place holder event.

[Playlist Placeholder] dialog box (workstation mode only) ► P205

The properties of the place holder are displayed.

➤ Properties of place holder

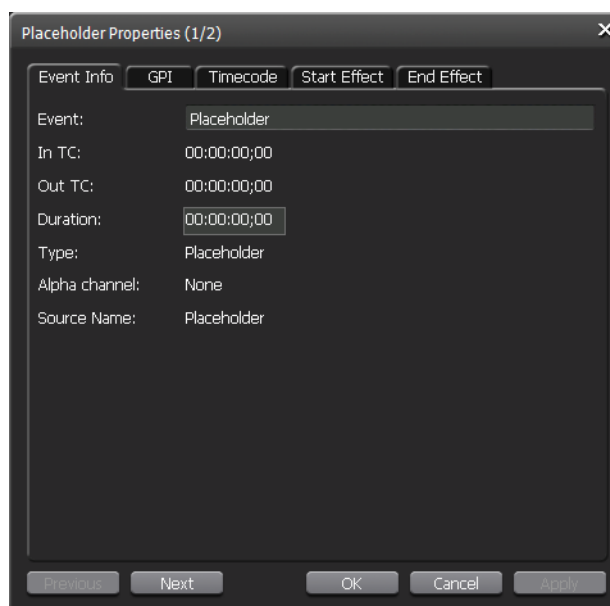

[Event Info] tab	<p>Displays the information on the place holder.</p> <p>You can check the event name, event type, In/Out points, duration, alpha channel presence, the name of the contents being linked, etc.</p> <p>You can change the event name and duration.</p>
[GPI] tab	<p>When controlling an external device with GPI output, allows to check or set the trigger event actions. (Only for P1 channel.)</p> <p>Controlling external devices from T2 with GPI output ▶ P241</p>
[Timecode] tab	<p>Specifies start timecode of an event. (Enabled when [According to event setting] is selected on the [Timecode] tab in the playlist property.)</p> <p>To use the start timecode of a media file, select [Source].</p> <p>To specify a start timecode, select [Specify start time], tap the entry area, and enter timecode.</p>
[Start Effect] tab	<p>Allows to check or set the effects for event starting (start effects).</p> <p>Setting effects on an event ▶ P114</p>
[End Effect] tab	<p>Allows to check or set the effects for event ending (end effects).</p> <p>Setting effects on an event ▶ P114</p>

2 Set each item and click [OK].

Replacing place holder on playlist

You can replace a set place holder to a clip.

- 1 Click the bin that includes the clip to be replaced with from the bin list on the [Bin] tab, and then click the clip to be replaced with from the contents list.

[Bin] tab ▶ P76

- 2 Right-click on the place holder, click [Placeholder] -> [Replace], and then click the clip to be replaced with.

The place holder is replaced with the clip.

TIP • Alternatively, drag & drop the clip that is selected on the contents list in the bin list to  in a place holder, to replace a place holder with a clip.

Replacing place holder by drag & drop operation ▶ P171

- You can make settings for replacing a place holder event.
[Playlist Placeholder] dialog box (workstation mode only) ▶ P205

Changing a playlist name

You can change the name of the playlist loaded to the Player channel.

- 1 Tap [Menu] in the playlist view, and then tap [Rename].
- 2 Enter a name and tap [OK].

Software keyboard ▶ P130

Checking playlist properties

You can check the properties of the playlist loaded to the Player channel.

- 1 Tap [Menu] in the playlist view, and then tap [Properties].

The properties of the playlist are displayed.

Playlist properties ▶ P81

Checking event properties

You can check the properties of events in the playlist loaded to the Player channel.

- 1 Tap and select an event in the playlist view.

The selected event is displayed with a blue frame.

- 2 Tap [Menu], and then tap [Event Properties].

The properties of the event are displayed.

➤ Event properties

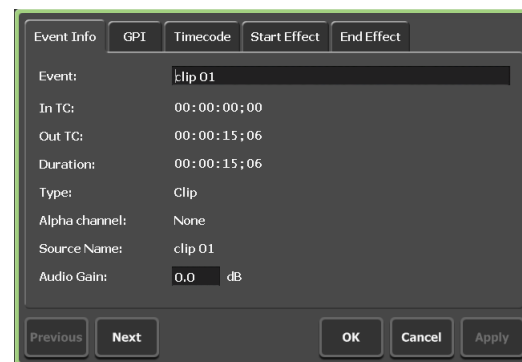

<p>[Event Info] tab</p>	<p>Displays the information of the event. You can check the event name, event type (clip or playlist), In/Out timecode, length, alpha channel presence, the name of the contents being linked, etc. Tapping the entry area allows to change the event name and audio gain. (For still images, the length can be changed.)</p>
<p>[GPI] tab</p>	<p>When controlling an external device with GPI output, allows to check or set the trigger event actions. (Only for P1 channel.) Controlling external devices from T2 with GPI output ▶ P241</p>
<p>[Timecode] tab</p>	<p>Specifies start timecode of an event. (Enabled only when [According to event setting] is selected in the [Timecode] tab in the playlist properties.) To use the start timecode of a media file, select [Source]. To specify a start timecode, select [Specify Start Time], tap the entry area, and enter timecode.</p>
<p>[Start Effect] tab</p>	<p>Allows to check or set the effects for event starting (start effects). Setting effects on an event ▶ P114</p>
<p>[End Effect] tab</p>	<p>Allows to check or set the effects for event ending (end effects). Setting effects on an event ▶ P114</p>

3 Tap [OK].

Changing the playlist type

You can select the playlist type (normal or timeline format). The playlist type can be changed only in the workstation mode.

Changing the playlist type ► P180

Setting marker

You can set markers with comments on a content being played back or a clip being recorded.

If markers are set, you can quickly cue up to a desired timecode position.

NOTE

- To record the marker information that are added after recording has stopped to the file with T2, perform one of the following operations.
 - Convert or export to Grass Valley HQX AVI or Grass Valley HQX MXF
 - Convert to MXF
- If an MXF (XDCAM format) file with markers has been exported to the XDCAM drive (SONY PDW-U1, PDW-U2), the marker information will not be recorded in the metadata.

TIP

- T2 marker information will be recorded in the following cases. You can use the marker information on EDIUS.
 - When markers are added on a clip that is being recorded with T2 (including when recording to an external folder or time-shift editing with EDIUS using direct access folder is being performed)
 - When a clip with markers is converted or exported to Grass Valley HQX AVI or Grass Valley HQX MXF
 - When a clip with markers is converted to MXF
 - When a playlist including a clip event with markers is converted to Grass Valley HQX AVI or MXF
- If a file that contains the following settings in the metadata of XDCAM or P2 source is imported, it will be imported as markers for T2.
 - Essence marks in the metadata of XAVC or XAVC S
 - Essence marks in the metadata of XDCAM or XDCAM EX
 - Memo list in the metadata of P2

Note that the markers set with T2 cannot be reflected in the original media file.

- In the workstation mode, you can assign keyboard shortcuts to marker operations or assign commands to mouse operations.

Changing keyboard shortcut assignment ► P172

Assigning commands to mouse operation ► P174

Showing marker list

You can display the marker list of the contents mounted on the Player channel.

1 Mount contents to the Player channel.

Loading contents to Player channel ▶ P97

2 Tap [Menu], [Tools], and then [Show Marker List].

The marker list will be displayed.

➤ Marker list

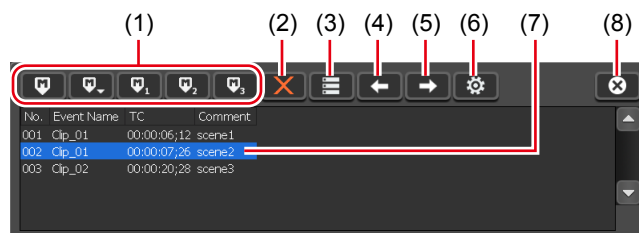

(1)	Add marker buttons	Adds a marker to the current position. After a marker has been added, a triangular marker icon appears on the scrubbing bar. Add marker buttons ▶ P125
(2)	[Delete marker]	Deletes markers selected on the marker list.
(3)	[Edit marker]	Displays the [Edit Marker] dialog box. You can edit timecodes and comments of markers. Edit (add) marker dialog box ▶ P126
(4)	[Move to previous marker]	Moves to the position of the marker previous to that selected in the marker list.
(5)	[Move to next marker]	Moves to the position of the marker next to that selected in the marker list.
(6)	[Setting]	Displays the [Marker] dialog box. [Marker] dialog box ▶ P124
(7)	Marker list	Displays the No., timecodes, and comments of markers. For markers set in a playlist, the event name will be displayed.
(8)	[Close]	Closes the marker list.

➤ **[Marker] dialog box**



<p>[Show add marker dialog when new marker is added]</p>	<p>By checking, displays the add marker dialog box when a marker is added. Edit (add) marker dialog box▶P126</p>
<p>[Show marker icons on the scrub bar]</p>	<p>By unchecking, hides the triangular marker icon that appears on the scrubbing bar. [When moving to edit point :] In the workstation mode, selects whether to include markers to the edit points when [Move to previous edit point] or [Move to next edit point] of the Player channel operation buttons is clicked.</p>
<p>[Marker Comment List :]</p>	<p>By tapping [Edit...], displays the dialog box to edit marker comment list to allow editing of marker comments. Marker comment list edit dialog box▶P127</p>

Showing marker list of clip being recorded

You can display the marker list of a clip that is being recorded.

1 Start recording in the Recorder-VTR or Recorder-live mode.

Recording by VTR control (Recorder-VTR mode)▶ P46

Recording live video (Recorder-live mode)▶ P48

2 Tap [Menu], [Tools], and then [Show Marker List].

The marker list will be displayed.

Marker list▶P123

Adding marker

This section shows the procedure to add a marker.

If marker comments are set in advance, you can quickly add a marker with comment while recording or playback.

Setting marker comment▶P127

- TIP**
- Markers can be set to the following files.
 - Clip being recorded with T2
 - Clips on T2
 - Clip event in a playlist on T2 (cannot set as playlist event)
 - Media files in the removable media (marker information cannot be imported to T2)

1 Display the marker list.

Showing marker list▶P123

Showing marker list of clip being recorded▶P124

2 While content is being played back (or while clip is being recorded), tap the add marker button at the point when the marker is to be added.

➤ Add marker buttons



(1)	[Add Marker]	Adds a marker (with no comment). If you want to add a comment at the time when a marker is added, check [Show add marker dialog when new marker is added] in the [Marker] dialog box. [Marker] dialog box▶P124
(2)	[Add Marker with Comment (0-9)]	By tapping and selecting [1] to [9], adds a marker with a preset marker comment (1 to 9). (When [0] is selected, a marker without comment is added.)
(3)	[Add Marker with Comment 1]	Adds a marker with a preset marker comment 1.
(4)	[Add Marker with Comment 2]	Adds a marker with a preset marker comment 2.
(5)	[Add Marker with Comment 3]	Adds a marker with a preset marker comment 3.

A triangular marker icon appears on the scrubbing bar.

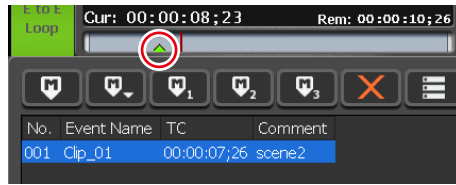

The markers added will be displayed in the marker list (No., timecodes, and comments). For a marker set to a clip event in playlist, the event name will be displayed.

Editing marker comment or timecode

1 Display the marker list.

Showing marker list ▶ P123

Showing marker list of clip being recorded ▶ P124

2 Tap and select a marker to edit on the marker list.

The yellow-green marker icon on the scrubbing bar indicates that the marker is selected.

3 Tap [Edit marker].

Marker list ▶ P123

The edit (add) marker dialog box appears.

➤ Edit (add) marker dialog box

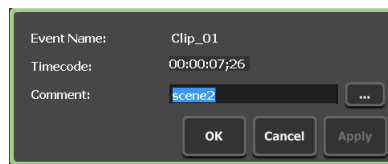

[Event Name :]	For markers set in a playlist, displays the event name.
[Timecode:]	For a marker set to the contents mounted on the Player channel, tapping the entry area allows to change the timecode.
[Comment :]	Displays the marker comment that is set. Tapping the entry area allows to edit the comment. Alternatively, tapping [...] allows to select a preset marker comment (1 to 9). Setting marker comment ▶ P127

[OK]	Closes the setting screen with saving the current settings.
[Cancel]	Closes the setting screen without saving the current settings.
[Apply]	Saves the current settings. You can keep on making settings of other items.

4 Set each item and tap [OK].

Tap [Apply] to keep on making settings of other items.

Setting marker comment

If marker comments are set in advance, you can quickly add a marker with comment while recording or playback.

You can set nine marker comments.

1 Display the marker list.

Showing marker list ▶ P123

Showing marker list of clip being recorded ▶ P124

2 Tap [Setting] in the marker list.

3 In the [Marker] dialog box, tap [Edit...].

Marker comment list edit dialog box appears.

➤ Marker comment list edit dialog box

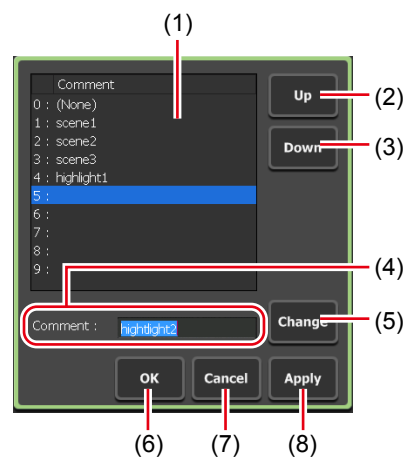

(1)	Marker comment list	Displays the list of marker comments (1 to 9). (No comment can be set for [0:].)
(2)	[Up]	Moves up the selected marker comment.

(3)	[Down]	Moves down the selected marker comment.
(4)	[Comment :]	Displays the comment selected in the marker comment list. Tapping the entry area allows to enter a comment.
(5)	[Change]	Changes the comment to that you enter in the entry area of [Comment :].
(6)	[OK]	Saves the current settings and closes the setting screen.
(7)	[Cancel]	Closes the setting screen without saving the current settings.
(8)	[Apply]	Saves the current settings. You can keep on setting other marker comments.

4 Tap one of [1:] to [9:] on the marker comment list, and then tap the entry area of [Comment :].

5 Enter a marker comment, and then tap [OK].

Software keyboard ► P130

6 Tap [Change].

The entered comment is reflected in the marker comment list.

7 Tap [OK].

Tap [Apply], and then you can keep on setting other marker comments.

Deleting marker

1 Display the marker list.

Showing marker list ► P123

Showing marker list of clip being recorded ► P124

2 Tap and select a marker to delete from the marker list.

The yellow-green marker icon on the scrubbing bar indicates that the marker is selected.

3 Tap [Delete marker].

Marker list ► P123

4 On the message that appears, tap [Yes].

Moving to marker position

For a marker set to the contents mounted on the Player channel, the current playback position can be moved to the marker position.

1 Display the marker list.

Showing marker list ► P123

2 Tap and select a desired marker in the marker list, and then tap [Move to previous marker] or [Move to next marker].

Marker list ► P123

The current playback position moves to the previous or next marker position.

The yellow-green marker icon on the scrubbing bar indicates that the marker is selected.

TIP

- In the [Marker] dialog box, check [Show marker icons on the scrub bar], click [When moving to edit point :], and select [Cue up on Markers], to include marker positions as the moving destination when the following operations is performed.

[Marker] dialog box ► P124

- In the workstation mode, when [Move to previous edit point] or [Move to next edit point] of the Player channel operation buttons is clicked
- In the front panel mode, when [Rew] + [Stop] buttons or [FF] + [Stop] buttons are pressed at the same time
- In the workstation mode, also you can move a marker in the marker list by double-clicking on it.

Entering characters and numerics

Entering characters

The operation to enter characters in each screen is described in this part.

NOTE • You cannot enter Japanese characters.

- 1 Tap the entry area of a screen.
- 2 Enter characters with the software keyboard.

➤ Software keyboard

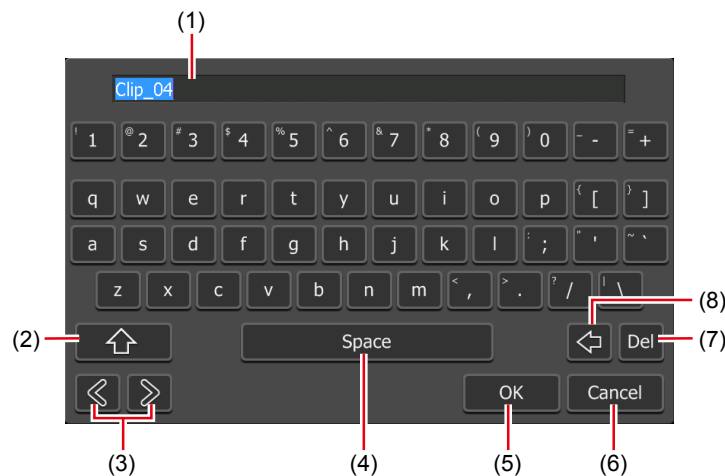

(1)	Entry area	Displays the characters entered with the software keyboard.
(2)	[Shift]	Switches upper/lower case of alphabets.
(3)	Cursor (left and right)	Moves the cursor in the entry area.
(4)	[Space]	Used as the space key.
(5)	[OK]	Fixes the entered characters and closes the software keyboard.
(6)	[Cancel]	Cancel the entry and closes the software keyboard.
(7)	[Del]	Deletes currently selected entry or deletes the character right after the cursor.
(8)	[BackSpace]	Deletes the character right before the cursor.

- 3 Tap [OK].

Entering timecode

The operation to enter timecode in each screen is described in this part.

1 Tap the timecode entry area of a screen.

2 Enter a timecode with the software keypad.

➤ Software keypad – Timecode

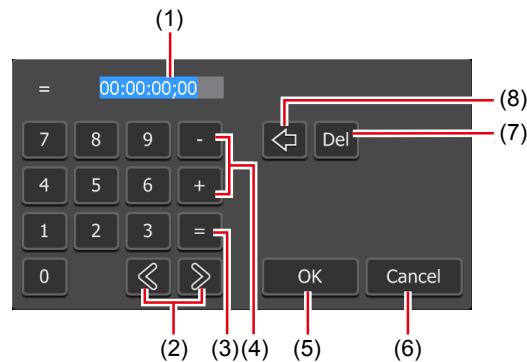

(1)	Entry area	Displays the timecode entered with the software keypad. According to the entered digits, the number will be automatically converted into “hour, minute, second, frame”. For example, enter “4321” for 43 seconds 21 frames.
(2)	Cursor (left and right)	Moves the cursor in the entry area.
(3)	[=]	Applies the entered value to the set value for timecode as it is.
(4)	[-]/[+]	Allows to enter reduced or increased value (relative value) from the current value. Reduces the set value by entering after tapping [-]. Increases the set value by entering after tapping [+].
(5)	[OK]	Fixes the entered value and closes the software keypad.
(6)	[Cancel]	Cancels the entry and closes the software keypad.
(7)	[Del]	Deletes currently selected entry or deletes the character right after the cursor.
(8)	[BackSpace]	Deletes the character right before the cursor.

3 Tap [OK].

Entering numerics

The operation to enter numerics in each screen is described in this part.

- 1 Tap the numeric entry area of a screen.
- 2 Enter numerics with the software keypad.

➤ Software keypad – Numeric

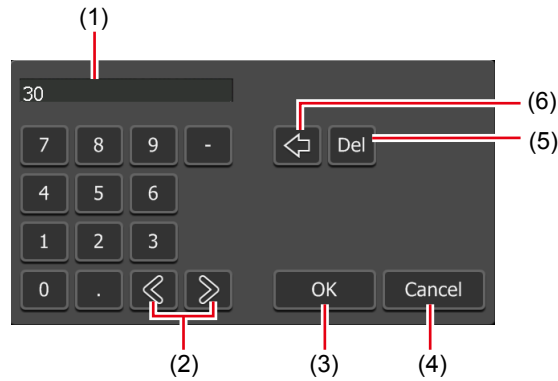

(1)	Entry area	Displays the numerics entered with the software keypad.
(2)	Cursor (left and right)	Moves the cursor in the entry area.
(3)	[OK]	Fixes the entered value and closes the software keypad.
(4)	[Cancel]	Cancel the entry and closes the software keypad.
(5)	[Del]	Deletes currently selected entry or deletes the character right after the cursor.
(6)	[BackSpace]	Deletes the character right before the cursor.

- 3 Tap [OK].

Section 9

Operations in Workstation Mode

This section describes screen elements of the workstation mode and functions available only in the workstation mode.

Screen elements

➤ Full display – 3ch view

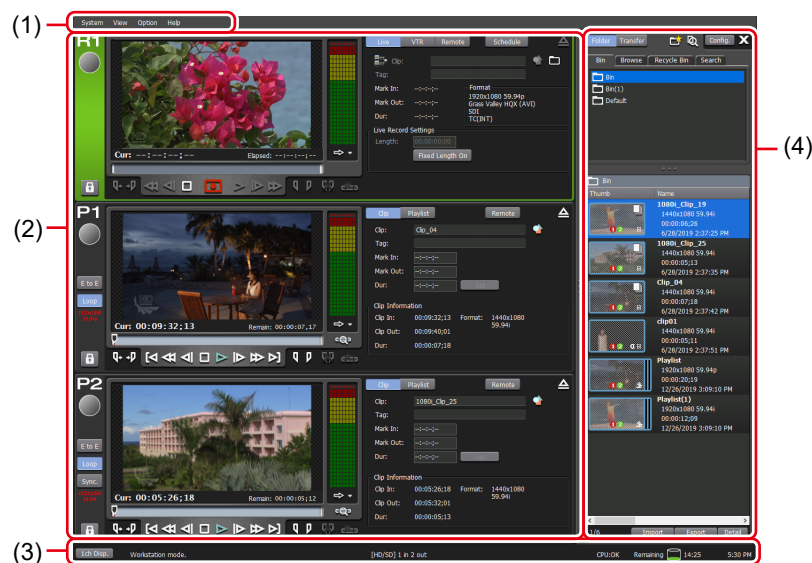

(1)	Menu bar	By clicking, displays related menu. Menu bar▶P134
(2)	Channel display part	Displays Recorder and Player channels in 3ch view. Recorder channel – 2ch/3ch view▶P135 Player channel – 2ch/3ch view▶P151
(3)	Status bar	Status bar▶P162
(4)	Bin/transfer screen display part	Performs contents management, import/export of media files, display of the setting screen, etc. Bin/transfer screen display part▶P163

➤ **Menu bar**

<p>[System]</p>	<p>By clicking, displays the next menu.</p> <p>[Switch to Front Panel mode] Switches from the workstation mode to the front panel mode.</p> <p>[Switch to Workstation mode] Switches from the front panel mode to the workstation mode.</p> <p>Switching from the front panel mode to the workstation mode▶P37</p> <p>[Lock Front Panel] Lock and unlock front panel. This mode is unlocked to push [R1]+[P1]+[P2]+ [SHTL/JOG] buttons same time also.</p> <p>[T2 to T2 Sync backup...] Makes a backup of all data to another T2.</p> <p>[Maintenance...] Switches to the maintenance mode.</p> <p>[Exit] Exits T2.</p> <p>Exiting T2 in workstation mode▶P36</p>
<p>[View]</p>	<p>By clicking, displays the next menu.</p> <p>[2ch (channel name 1 + channel name 2)] Displays the two specified channel names in the channel display part.</p> <p>[3ch] Displays three channel names in the channel display part.</p>
<p>[Option]</p>	<p>By clicking, displays the next menu.</p> <p>[Log] Sets the log level and displays logs. Checking logs of operations and processes▶P186</p> <p>[Remove media...] Disconnects a removable drive such as USB removable media, XDCAM, P2, etc.</p> <p>[Customize] Assigns keyboard shortcuts and sets mouse operations. Changing keyboard shortcut assignment▶P172 Assigning commands to mouse operation▶P174</p>

<p>[Help]</p>	<p>By clicking, displays the next menu.</p> <p>[About T2] Displays the version of T2.</p>
----------------------	--

➤ Recorder channel – 2ch/3ch view

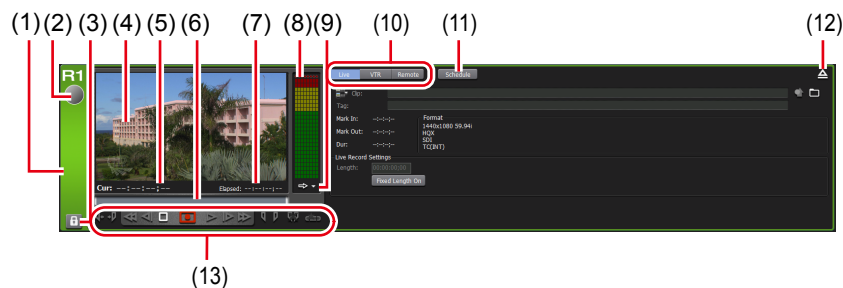

(1)	Recorder channel tab	By clicking, selects and highlights the Recorder channel.
(2)	Status	Indicates the recording progress status.
(3)	[Locked]	Locks Recorder channel operations. While the operations are locked, [Locked] and [R1] buttons light in red. Clicking it again releases the lock.
(4)	Preview	Displays the video currently played back. In full screen mode, right-click on it, and then click [Full Screen Mode] or double-click on it.
(5)	[Cur:]	Indicates the current timecode.
(6)	Scrubbing bar	Indicates the recording progress status.
(7)	[Elapsed:]	Indicates the elapsed time of recording by timecode display.
(8)	Audio level display	Displays the audio playback level.
(9)	[Switch to the detail display]	Switches to the detail view. Audio level detail display (Recorder channel) ▶ P147 Timecode Status display ▶ P148 Marker list view ▶ P150

(10)	Recording mode	Switches the recording mode (Recorder-live mode /Recorder-VTR mode/Recorder-remote mode). Recorder-live mode▶P136 Recorder-VTR mode▶P142 Recorder-remote mode▶P144
(11)	[Schedule]	In the Recorder-live mode, automatically starts recording operation at a specified time, and ends it at a specified time. Recorder-live mode / schedule mode▶P137
(12)	[Unload]	Unloads the video loaded to the Recorder channel.
(13)	Operation buttons	Operation buttons of Recorder channel▶P146

➤ Recorder-live mode

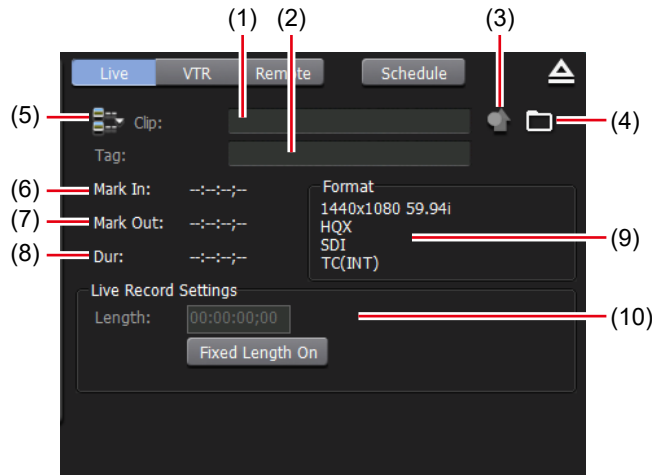

(1)	[Clip:]	Enter the name of the clip currently recorded.
(2)	[Tag:]	Enter a tag for search to the clip currently recorded.
(3)	[Properties]	Displays the properties of the clip currently recorded.
(4)	[Setting of ingesting]	Sets the saving destination and naming rule of clips being recorded. Setting of ingesting dialog box▶P145

(5)	[Set the clip name for next ingest file...]	Displays the dialog box to set the name of the clip to be recorded next. The set clip name is displayed in [Clip:].
(6)	[Mark In:]	Indicates the In point timecode of the clip currently recorded.
(7)	[Mark Out:]	Indicates the Out point timecode of the clip currently recorded.
(8)	[Dur:]	Indicates the time length (duration) of the clip currently recorded.
(9)	[Format]	Displays the video size, frame rate, input settings, port used for input, source TC (TC (LTC)/SDI (VITC)/TC (INT)), etc.
(10)	[Live Record Settings]	[Fixed Length On] By clicking to set it on, automatically ends recording after the duration from the start point specified in [Length:].

TIP

- While recording to an external device, [Setting of ingesting] turns green to indicate that the recording to an external device is performed.

➤ Recorder-live mode / schedule mode

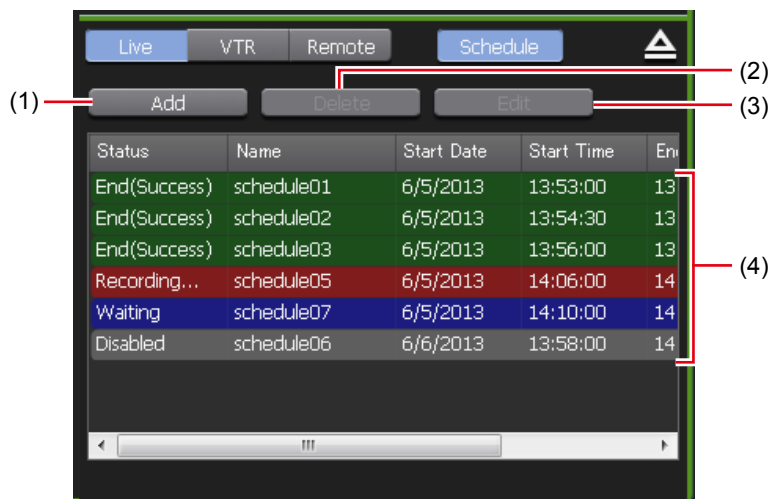

(1)	[Add]	Creates a new schedule. Schedule Recording dialog box ▶ P139
(2)	[Delete]	Deletes schedules selected on the schedule list.

(3)	[Edit]	<p>Changes the date and time etc. of a schedule selected on the schedule list. Displays the Schedule Recording dialog box.</p> <p>Schedule Recording dialog box►P139</p>
(4)	Schedule list	<p>Displays information on new schedules and schedules that have already been recorded. The status, name, start time, end time, and type of schedules can be viewed.</p> <p>Status of Schedule►P138</p>

TIP • Select a schedule on the schedule list, right-click on it, and then click [Select All], to select all schedules.

► **Status of Schedule**

Status	Details
[Waiting]	Schedule recording is waiting for next start time.
[Retrying]	Recording is retrying.
[Recording]	Recording is in process.
[End]	Recording is completed.
[Disabled]	The schedule is disabled. Recording will not be executed.

Result	Details
[Success]	Recording is completed successfully.
[Error]	An error is occurred during recording.
[Cancel]	Recording is canceled in the middle.

➤ **Schedule Recording dialog box**

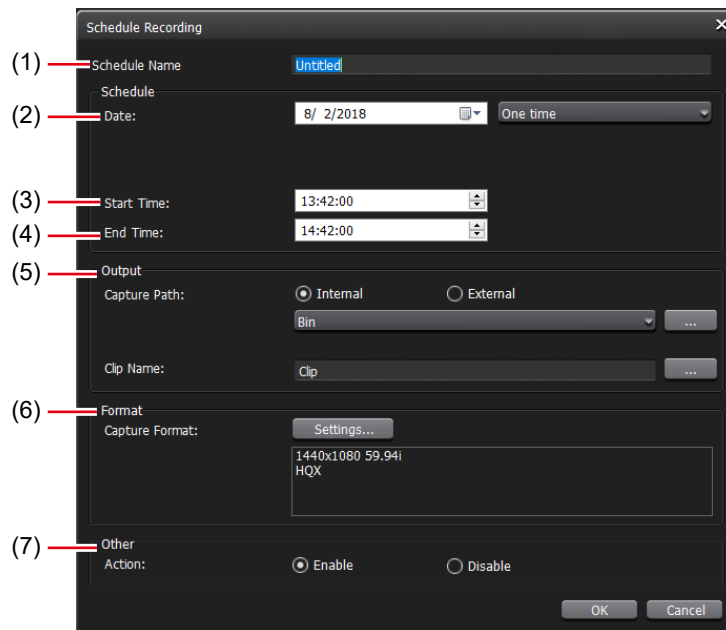

(1)	[Schedule Name]	Enter the schedule name.
(2)	[Date :] ([Start Date :], [End Date :], [Day of week :])	<p>Selects [One time], [Every day], or [Every week] from the list.</p> <p>Selecting [Every day] or [Every week] repeats recording operation for a fixed period of time.</p> <p>[One time] By clicking the icon on the calendar, allows to set the date to automatically start recording.</p> <p>[Every day] Changes [Date :] to [Start Date :]. Checking [Set end date] displays [End Date :]. Clicking the icon on the calendar allows to set the [Start Date :] and [End Date :].</p> <p>[Every week] Changes [Date :] to [Start Date :] and displays [Day of week :]. Checking [Set end date] displays [End Date :] and [Day of week :]. Clicking the icon on the calendar allows to set the [Start Date :] and [End Date :]. Set [Day of week :] to the day of the week when you wish to record.</p>

(3)	[Start Time :]	Sets the time to automatically start recording.
(4)	[End Time :]	Sets the time to automatically end recording.
(5)	[Output]	<p>Selects the saving destination of the clips to be recorded.</p> <p>[Capture Path :] Select [Internal] to save clips to T2. The bin that is registered to T2 is displayed from the list. Also clicking [...] allows to set a newly created bin to the saving destination. Select [External] to save clips to a destination other than T2. If <non-registered> is indicated, click [...] and set the saving destination.</p> <p>[Clip Name :] Sets the naming rule of clips to be saved. Enter the clip name. Clicking [...] enters [Date], [Time] and/or [Schedule Time] after the clip name automatically.</p>
(6)	[Format]	<p>[Capture Format :] Sets the format of the clips to be recorded. Clicking [Settings...] displays the Capture Format dialog box.</p> <p>Capture Format dialog box ► P141</p>
(7)	[Other]	<p>[Action] Selects if the schedule is to be executed or not from [Enable] and [Disable].</p>

NOTE

- The following schedules cannot be added or changed.
 - A schedule that overlaps to a registered schedule
 - A schedule whose recording start time is within one minute
 - A schedule that has already been recorded
- It may take more than one minute to finish recording after "recording long time" or "recording in the external storage". In this case, next schedule recording is started after the last recording is completed.

TIP

- [Date :] ([Start Date :], [End Date :]), [Start Time :], and [End Time :] can also be set by moving the mouse wheel .

➤ Capture Format dialog box

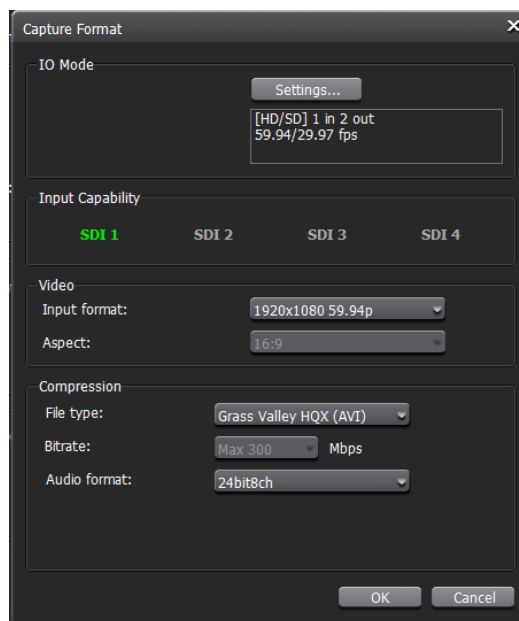

[IO Mode]	By clicking [Settings...], selects an IO mode and frame rate. [IO Mode Setting] dialog box▶P142
[Input Capability]	According to the selection for [IO Mode], displays the connector to be used for input with green highlight.
[Video]	[Input format :] Selects the format for video input. [Aspect :] For SD input, selects the aspect ratio.
[Compression]	Part of available setting items differ according to the codec selected for [File type:]. [File type :] Selects the compression format. [Bitrate :] Selects a bit rate that supports the compression format. [Audio format :] Selects an audio format that supports the compression format. [ClosedGOP] By checking this item when a compatible codec is used, all the information will be included within the GOP. It increases the data size, but allows re-editing with editor software that allows editing of GOP data. Uncheck it normally.

➤ [IO Mode Setting] dialog box

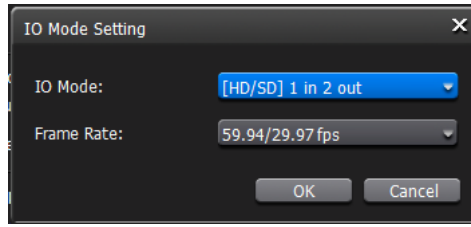

[IO Mode:]	Selects an IO mode option. IO mode list ▶ P263
[Frame Rate:]	Selects a frame rate for recording. <ul style="list-style-type: none"> • [59.94 / 29.97 fps]: Either of 59.94p, 29.97p, and 59.94i • [50 / 25 fps]: Either of 50p, 25p, and 50i • [24 fps]: Either of 24p and 24PsF • [23.98 fps]: Either of 23.98p and 23.98PsF

Note

- At the start of recording, if the settings of the IO mode and frame rate of the registered schedule differ from those of the current settings, an error will result.

TIP

- The IO modes available on your T2 differ depending on the T2 model type.
IO mode list ▶ P263

➤ Recorder-VTR mode

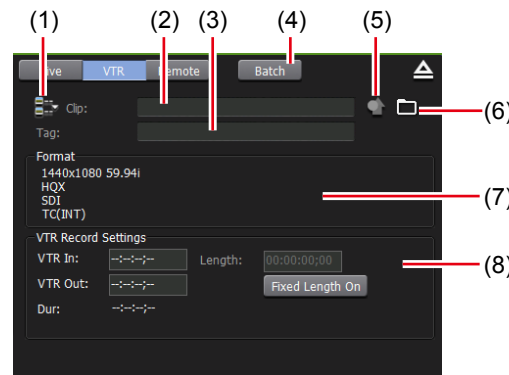

(1)	[Set the clip name for next ingest file...]	Displays the dialog box to set the name of the clip to be recorded next. The set clip name is displayed in [Clip:].
(2)	[Clip:]	Enter the name of the clip currently recorded.

(3)	[Tag:]	Enter a tag for search to the clip currently recorded.
(4)	[Batch]	Switches to the Recorder-VTR batch mode. Recording sources at once (batch capturing) ▶ P176
(5)	[Properties]	Displays the properties of the clip currently recorded.
(6)	[Setting of ingesting]	Sets the saving destination and naming rule of clips being recorded. Setting of ingesting dialog box ▶ P145
(7)	[Format]	Displays the video size, frame rate, input settings, port used for input, source TC (TC (LTC)/SDI (VITC)/TC (INT)), etc.
(8)	[VTR Record Settings]	<p>[VTR In:] Enter the In point timecode of the clip currently recorded.</p> <p>[VTR Out:] Enter the Out point timecode of the clip currently recorded.</p> <p>[Length:] Indicates the time length (duration) of the clip currently recorded.</p> <p>[Fixed Length On] By clicking to set it on, automatically ends recording after the duration from the start point specified in [Length:].</p>

TIP

- While recording to an external device, [Setting of ingesting] turns green to indicate that the recording to an external device is performed.

➤ Recorder-remote mode

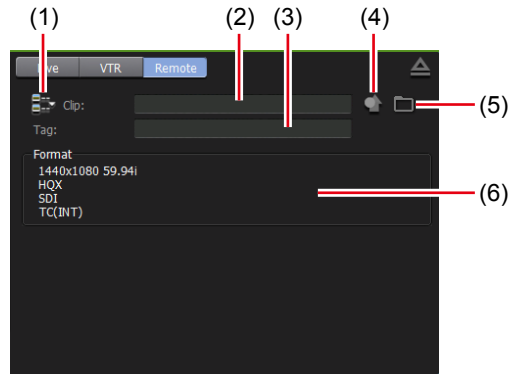

(1)	[Set the clip name for next ingest file...]	Displays the dialog box to set the name of the clip to be recorded next. The set clip name is displayed in [Clip:].
(2)	[Clip:]	Enter the name of the clip currently recorded.
(3)	[Tag:]	Enter a tag for search to the clip currently recorded.
(4)	[Properties]	Displays the properties of the clip currently recorded.
(5)	[Setting of ingesting]	Sets the saving destination and naming rule of clips being recorded. Setting of ingesting dialog box▶P145
(6)	[Format]	Displays the video size, frame rate, input settings, port used for input, source TC (TC (LTC)/SDI (VITC)/TC (INT)), etc.

TIP • While recording to an external device, [Setting of ingesting] turns green to indicate that the recording to an external device is performed.

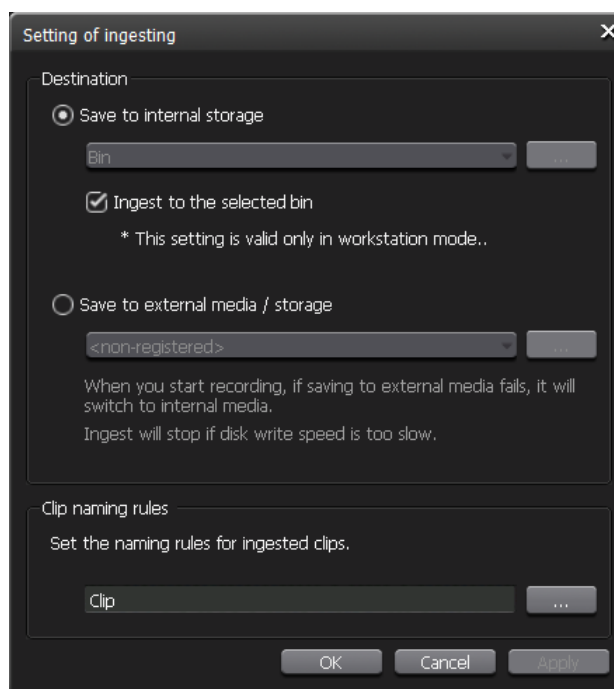

➤ Setting of ingesting dialog box

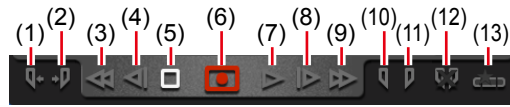

<p>[Destination]</p>	<p>Selects the saving destination of the clips to be recorded.</p> <p>Select [Save to internal storage] to save clips to T2. Select the bin that is registered to T2 from the list. Also clicking [...] allows to set a newly created bin to the saving destination.</p> <p>Checking [Ingest to the selected bin] saves clips to the bin selected in the bin display area.</p> <p>To record data to a destination other than T2, select [Save to external media / storage], and then select an external media/storage from the list.</p> <p>If <non-registered> is indicated, click [...] and set the saving destination.</p>
<p>[Clip naming rules]</p>	<p>Sets the naming rule by entering a name of clips to be saved.</p> <p>The data is recorded by a clip name with the recorded date and time, according to the items selected in [Date] and/or [Time].</p> <p>If the name of the clip to be recorded next has been set in the Recorder channel, the clip name setting for the next recorded clip is prioritized.</p>

➤ **Operation buttons of Recorder channel**



(1)	[Cue(In)] ^{*1}	Moves the VTR to the In point.
(2)	[Cue(Out)] ^{*1}	Moves the VTR to the Out point.
(3)	[Rewind] ^{*1}	Rewinds the VTR.
(4)	[Move to the previous frame] ^{*1}	By every click, moves back the VTR frame by frame.
(5)	[Stop]	Stops playback or recording.
(6)	[Record]	<p>Starts recording. The icon display changes depending on the recording mode.</p> <p> : Indicates that a recording stop operation is necessary.</p> <p> : Indicates that it is a fixed length recording.</p> <p> : Indicates that In point and Out point are set.</p>
(7)	[Play] ^{*1}	Plays the VTR.
(8)	[Move to the next frame] ^{*1}	By every click, moves forward the VTR frame by frame.
(9)	[FastFwd] ^{*1}	Fast forwards the VTR.
(10)	[Mark(In)]	Sets In point to the current position.
(11)	[Mark(Out)]	Sets Out point to the current position.
(12)	[Clear (In/Out)]	Clears set In/Out points.
(13)	[Create Subclip] ^{*2}	Creates a sub clip between In-Out points set while recording, and saves it as highlight.

*1 Only for Recorder-VTR mode.

*2 Only for Recorder-live mode. However, if the video being recorded is saved to an external media or storage, a sub clip cannot be created.

➤ **Recorder channel – 1ch view**

The display is same as that of Recorder channel – 3ch view.

Recorder channel – 2ch/3ch view ▶ P135

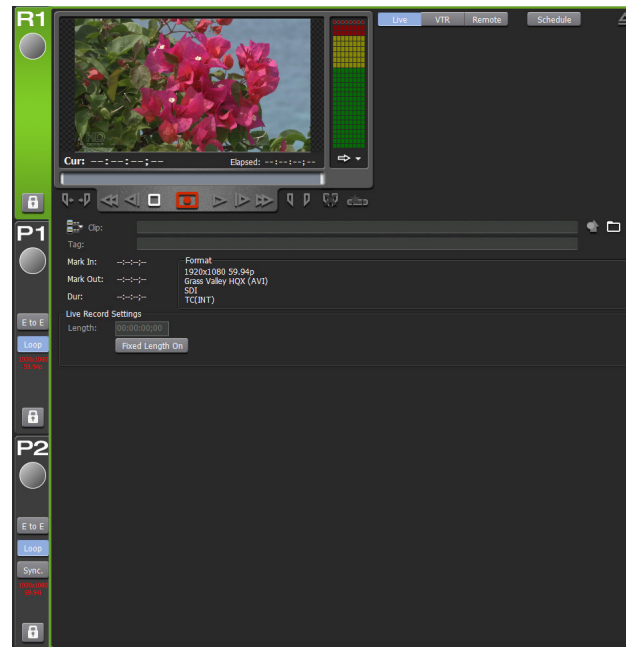

➤ **Audio level detail display (Recorder channel)**

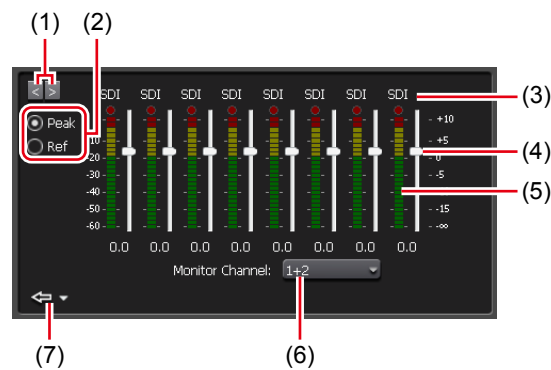

(1)	[<]/[>]	Switches the detail display
(2)	Switching of display scale	Selecting [Peak] makes the maximum level to 0 dB. Selecting [Ref] makes the set audio reference level as the standard level. You can set the audio reference level in [Audio reference level:] from [General] -> [Hardware] tab in the setting screen. General – Hardware settings ▶ P189
(3)	Input port	Indicates the port used for input.

(4)	Gain slider	Not available.
(5)	Level meter	Displays the audio playback level for each track.
(6)	Monitor channel	Indicates the channel that monitors the audio level. You can select a channel to monitor with the headphone jack on the front panel or the audio monitor jack on the rear panel.
(7)	[Close]	By clicking, closes the audio level detail display. By clicking the triangular list button on the right, you can also switch the screen to another detail view.

➤ **Timecode Status display**

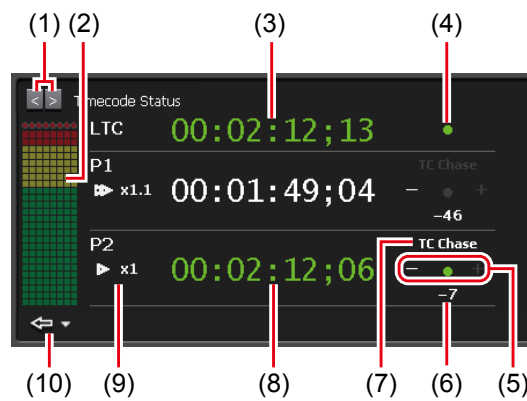

(1)	[<]/[>]	Switches the detail display.
(2)	Audio level meter	Displays the audio level meter of the channel whose timecode is displayed.
(3)	LTC timecode	Displays the timecode input to LTC. When the timecode is locked, this is displayed in green.
(4)	LTC lock status	Lights up in green (lock status) when the timecode input to LTC is confirmed to progress frame by frame correctly. If the timecode has stopped or does not progress frame by frame, the status will not be locked.

(5)	TC lock status	Lights up in green (lock status) when the timecode of the Player channel synchronizes with the frame accuracy of the LTC timecode. A plus is displayed if it is ahead of the LTC timecode, and a minus is displayed if it is behind.
(6)	Frame deviation number	Displays the frame deviation to the LTC timecode. A plus is displayed if it is ahead, and a minus is displayed if it is behind. The number is not displayed when the playback is synchronized with the same timecode or when it has stopped. -120 to +120 can be displayed.
(7)	Remote status	The remote mode set in the Player channel is displayed. Lights up in white when remote control is enabled. Remote Control ► P236
(8)	Current timecode	Displays the current timecode of the Player channel. When the timecode is locked, it is displayed in green. General – Hardware settings ► P189
(9)	Playback speed	Indicates the current playback speed (times).
(10)	[Close]	By clicking, closes the audio level detail display. By clicking the triangular list button on the right, you can also switch the screen to another detail view.

➤ Marker list view

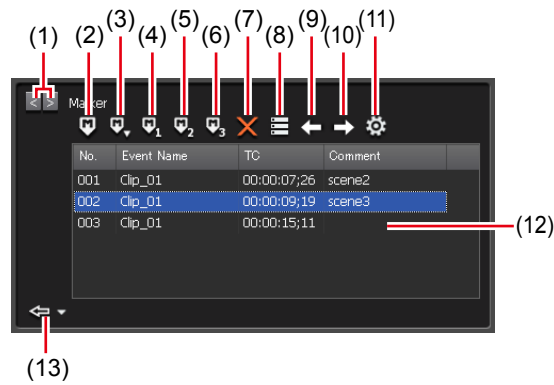

(1)	[<]/[>]	Switches the detail view.
(2)	[Add Marker]	Adds a marker (with no comment). If you want to add a comment at the time when a marker is added, check [Show add marker dialog when new marker is added] in the [Marker] dialog box.
(3)	[Add Marker with Comment (0-9)]	By clicking and selecting [1] to [9], adds a marker with a preset marker comment (1 to 9). (When [0] is selected, a marker without comment is added.)
(4)	[Add Marker with Comment 1]	Adds a marker with a preset marker comment 1.
(5)	[Add Marker with Comment 2]	Adds a marker with a preset marker comment 2.
(6)	[Add Marker with Comment 3]	Adds a marker with a preset marker comment 3.
(7)	[Delete marker]	Deletes markers selected on the marker list.
(8)	[Edit marker]	Displays the [Edit Marker] dialog box. You can edit timecodes and comments of markers.
(9)	[Move to previous marker]*1	Moves to the position of the marker previous to that selected in the marker list.
(10)	[Move to next marker]*1	Moves to the position of the marker next to that selected in the marker list.
(11)	[Setting]	Displays the [Marker] dialog box.

(12)	Marker list	Displays the No., timecodes, and comments of markers. For markers set in a playlist, displays the event name.
(13)	[Close]	By clicking, closes the marker list view. By clicking the triangular list button on the right, you can also switch the screen to another detail view.

*1 Not available for Recorder channel.

➤ **Player channel – 2ch/3ch view**

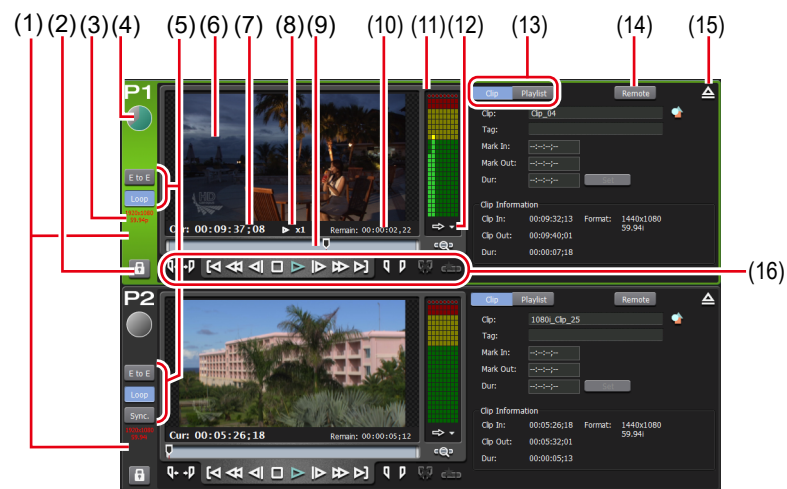

(1)	Player channel tab	By clicking, selects and highlights the Player channel.
(2)	[Locked]	Locks Player channel operations. While the operations are locked, [Locked] and [P1] (or [P2] button) buttons light in red. Tapping it again releases the lock.
(3)	Output profile	Indicates the output profile of the channel.
(4)	Status	Indicates the playback progress status.
(5)	Playback mode	Switches on and off of the current playback mode (sync mode, E to E mode, loop playback mode) of the Player channel. While the Recorder channel is played back in E to E mode, the E to E indication is shown in blue text. While the Player channel is played back, the indication is shown in white text.

(6)	Preview	<p>Displays the video currently played back. To update the thumbnail of the contents with the video of the current position, right-click the preview and click [Set Thumbnail Frame]. To change to full screen mode, right-click on it, and then click [Full Screen Mode] or double-click on it. From the menu that appears by right-clicking on the preview screen, clicking [On Screen Display] allows to set the following items.</p> <p>[Off] Does not show on-screen display on the Player channel.</p> <p>[Both] Shows on-screen display both on the Player channel preview of the T2 screen and on the output video from the SDI terminal.</p> <p>[PC Preview only] Shows on-screen display only on the Player channel preview of the T2 screen. On-screen display is not shown on the output video from the SDI terminal.</p> <p>[Settings...] Sets the indication contents of on-screen display shown on the Player channel. On-screen display detailed settings dialog box ▶ P106</p>
(7)	[Cur:]	Indicates the current timecode.
(8)	Playback speed	Indicates the current playback speed (times).
(9)	Scrubbing bar	Indicates the playback progress status and icons of set In/Out points.
(10)	[Remain:]	Indicates the timecode of the remaining time.
(11)	Audio level display	Displays the audio playback level.
(12)	[Switch to the detail display]	<p>Switches to the detail view. Audio level detail display (Player channel) ▶ P160 VAR speed control (Player channel) ▶ P161 Timecode Status display ▶ P148 Marker list view ▶ P150</p>

(13)	[Clip]/ [Playlist]	Switches to the clip view or playlist view. Player channel (clip view) – 2ch/3ch view▶P154 Player channel (playlist view) – 2ch/3ch view▶P155
(14)	[Remote]	Switches to the Player-remote mode.
(15)	[Unload]	Unloads the contents loaded on the Player channel.
(16)	[Operation Button]	Operation buttons of Player channel▶P156

➤ **Player channel (clip view) – 2ch/3ch view**

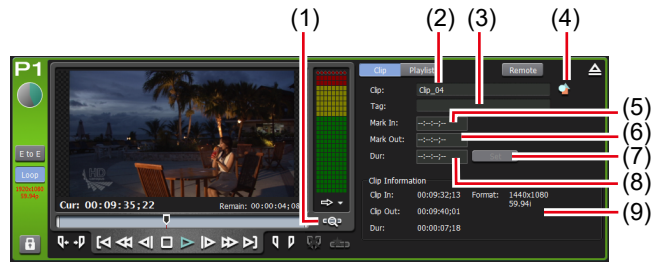

* (1) to (9) are common in P2 channel.

(1)	[Zoom]	Switches the display scale of the scrubbing bar. Clicking it displays [Zoom] in red, and displays the In-Out pints of the clip as the whole scale. Clicking it again returns the display to the original scale and displays the whole clip.
(2)	[Clip:]	Indicates the name of the loaded clip. Also allows to edit the clip name.
(3)	[Tag:]	Indicates the tag for search of the loaded clip. Also allows to edit the tag.
(4)	[Properties]	Displays the properties of the clip currently loaded.
(5)	[Mark In:]	Indicates the In point timecode of the clip. Also allows to enter and edit the In point timecode.
(6)	[Mark Out:]	Indicates the Out point timecode of the clip. Also allows to enter and edit the Out point timecode.
(7)	[Set]	Trims the clip between the set In-Out points.
(8)	[Dur:]	Indicates the time length (duration) of the clip. Also allows to enter and edit the timecode of the duration.
(9)	[Clip Contents]	Displays the In and Out points of the clip, duration of the clip, video size of the clip, and frame rate.

➤ Player channel (playlist view) – 2ch/3ch view

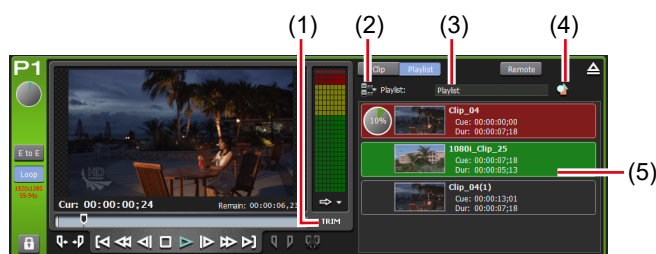

* (1) to (5) are common in P2 channel.

(1)	[TRIM]	Switches to the TRIM mode. You can edit the In/Out points of the event selected in the event list. Player channel (playlist view) – 1ch view/TRIM mode ▶ P158
(2)	[Playlist Menu]	Displays the related menu.
(3)	[Playlist:]/ [Timeline:]	Indicates the name of the loaded playlist. Also allows to edit the playlist name. [Playlist:] Playlist in the normal format. [Timeline:] Playlist in the timeline format. Changing the playlist type ▶ P180
(4)	[Properties]	Displays the properties of the playlist currently loaded.
(5)	Event list	Displays the list of events in the playlist. By right-clicking the event, displays the related menu. The background color of the event indicates the current status of the event. <ul style="list-style-type: none"> • Red indicates that the event has the playback position on the scrubbing bar. • Green indicates the next event of the event that has the playback position on the scrubbing bar. • Blue indicates that the event is selected. The background color of the event can be changed to your preferred color. [Playlist View Style:] dialog box (workstation mode only) ▶ P204

➤ **Operation buttons of Player channel**



(1)	[Cue(In)]	Moves to the In point of the contents.
(2)	[Cue(Out)]	Moves to the Out point of the contents.
(3)	[Move to previous edit point]	In the TRIM mode of clip view or playlist view, moves to the previous edit point (top of the clip, In/Out point after trimmed) by every click. In the playlist view, moves to the In point of the previous event. It also allows to include markers as edit points. [Marker] dialog box ► P124
(4)	[Rewind]	Rewinds the contents. By every click, switches the speed to 2 to 32 times (5 levels) and plays in backward.
(5)	[Move to the previous frame]	By every click, moves back the contents frame by frame.
(6)	[Stop]	Stops playback.
(7)	[Play]	Plays the contents.
(8)	[Move to the next frame]	By every click, moves forward the contents frame by frame.
(9)	[FastFwd]	Fast forwards the contents. By every click, switches the speed to 2 to 32 times (5 levels) and plays.
(10)	[Move to next edit point]	In the TRIM mode of the clip view or playlist view, moves to the next edit point (In/Out point after trimmed, end of the clip) by every click. In the playlist view, moves to the In point of the next event. If you play recording data, move to latest recording point. It also allows to include markers as edit points. [Marker] dialog box ► P124

(11)	[Mark(In)]	Sets In point to the current position. After In point has been set, the In point icon appears on the scrubbing bar.
(12)	[Mark(Out)]	Sets Out point to the current position. After Out point has been set, the Out point icon appears on the scrubbing bar.
(13)	[Clear (In/Out)]	Clears set In/Out points.
(14)	[Create Subclip]	Creates a sub clip between In-Out points set, and saves it as highlight.

➤ Player channel (clip view) – 1ch view

The display is same as that of Player channel (clip view) – 3ch view.

Player channel – 2ch/3ch view ▶ P151

Player channel (clip view) – 2ch/3ch view ▶ P154

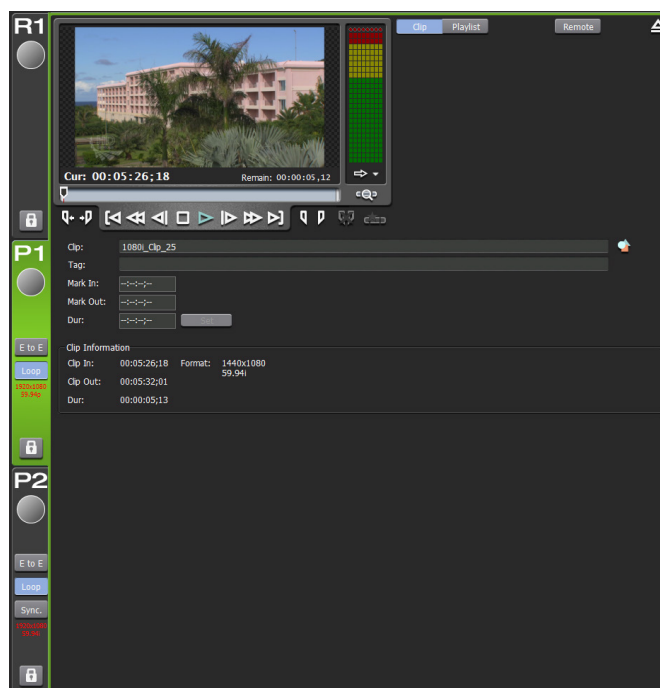

➤ **Player channel (playlist view) – 1ch view/TRIM mode**

The preview and operation button parts are same as that of Player channel (playlist view) – 3ch view.

Player channel – 2ch/3ch view ▶ P151

Player channel (playlist view) – 2ch/3ch view ▶ P155

The elements which differ from that of Player channel (playlist view) – 3ch view are described here.

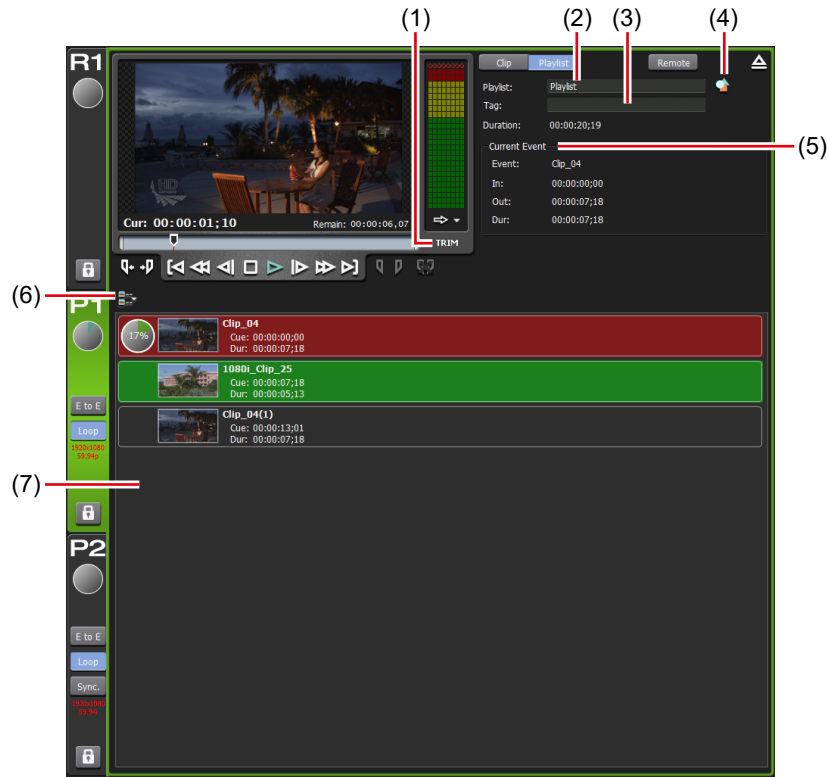

* (1) to (7) are common in P2 channel.

(1)	[TRIM]	Switches on and off of the TRIM mode. Displayed in red during in the TRIM mode. By clicking when in the TRIM mode, exits the TRIM mode.
(2)	[Playlist:]/ [Timeline:]	Indicates the name of the loaded playlist. Also allows to edit the playlist name. [Playlist:] Playlist in the normal format. [Timeline:] Playlist in the timeline format. Changing the playlist type ▶ P180

(3)	[Tag:]	Indicates the tag for search of the loaded playlist. Also allows to edit the tag.
(4)	[Properties]	Displays the properties of the playlist currently loaded.
(5)	[Current Event]	<p>Displays the information of the event being played.</p> <p>[Event:] Indicates the name of the event. Also allows to edit the event name in the TRIM mode.</p> <p>[In:] Indicates the timecode of the In point. Also allows to edit the In point timecode in the TRIM mode.</p> <p>[Out:] Indicates the timecode of the Out point. Also allows to edit the Out point timecode in the TRIM mode.</p> <p>[Dur:] Indicates the timecode of the length of the event (duration). Also allows to edit the timecode of the duration in the TRIM mode.</p> <p>[Set] Displays only in the TRIM mode. Trims between the set In-Out points.</p>
(6)	[Playlist Menu]	Displays the related menu.

(7)	Event list	<p>Displays the list of events in the playlist. By right-clicking the event, displays the related menu.</p> <p>The background color of the event indicates the current status of the event.</p> <ul style="list-style-type: none"> • Red indicates that the event has the playback position on the scrubbing bar. • Green indicates the next event of the event that has the playback position on the scrubbing bar. • Blue indicates that the event is selected. <p>The background color of the event can be changed to your preferred color.</p> <p>[Playlist View Style:] dialog box (workstation mode only) ► P204</p>
-----	-------------------	--

➤ **Audio level detail display (Player channel)**

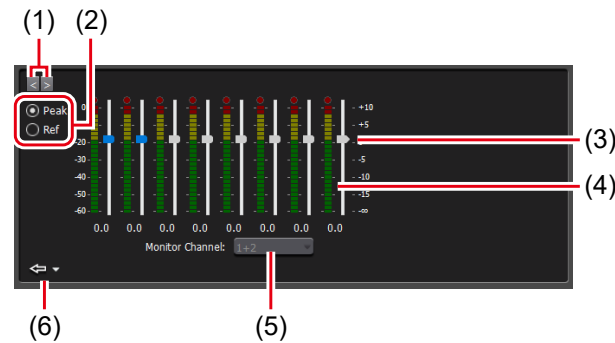

(1)	[<]/[>]	Switches the detail display.
(2)	Switching of display scale	<p>Selecting [Peak] makes the maximum level to 0 dB.</p> <p>Selecting [Ref] makes the set audio reference level as the standard level.</p> <p>You can set the audio reference level in [Audio reference level:] from [General] -> [Hardware] tab in the setting screen.</p> <p>General – Hardware settings ► P189</p>
(3)	Gain slider	Adjusts the gain of each channel by moving the slider.
(4)	Level meter	Displays the input audio level for each track.

(5)	Output channel	Allows to select a channel to output from the headphone jack on the front panel or the audio monitor jack on the rear panel.
(6)	[Close]	By clicking, closes the audio level detail display. By clicking the triangular list button on the right, you can also switch the screen to another detail view.

➤ VAR speed control (Player channel)

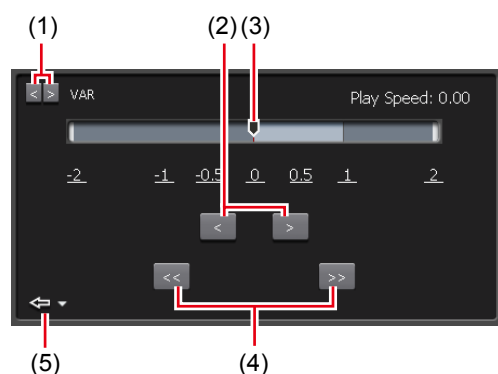

(1)	[<]/[>]	Switches the detail display.
(2)	[<]/[>]	By every click, increases or decreases the playback speed by 0.01 time.
(3)	Speed specifying bar	By clicking on the speed specifying bar or the value indicating the speed, specifies the playback speed within the range of -2 to +2 times.
(4)	[<<]/[>>]	By every click, increases or decreases the playback speed by 0.1 time.
(5)	[Close]	By clicking, closes the VAR speed control. By clicking the triangular list button on the right, you can also switch the screen to another detail view.

TIP

- The timecode status display is the same as that of Recorder channel.

Timecode Status display ▶ P148

➤ **Status bar**

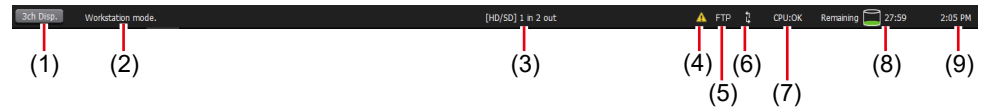

(1)	[3ch(2ch) Disp.]/ [1ch Disp.] switching	Switches 3ch(2ch) view and 1ch view.
(2)	Operation mode	Displays the current operation mode (workstation mode/front panel mode).
(3)	IO mode	Displays the current IO mode. By clicking, displays the [IO Mode Setting] dialog box where you can change the IO mode. [IO Mode Setting] dialog box ▶ P142
(4)	Log notification icon	Notifies a warning or error log with an icon when it occurs. Clicking the icon displays the [Log] dialog box and allows to check the details.
(5)	[FTP]	Indicates that the FTP server of T2 is in use.
(6)	Transfer process icon	Indicates an icon that notifies import, export, or file conversion is in process.
(7)	[CPU]	Indicates the CPU load status of T2.
(8)	Remaining HDD (remaining time)	Displays the estimated recording time available on HDD. When the remaining capacity reduces, the icon is displayed in red.
(9)	Time	Displays the current time. Clicking this part displays the date and time setting dialog box that enables to change the set time. Date and time setting dialog box ▶ P206

NOTE

- If the  icon appears on the status bar, there is a problem with the data drive. Consult the support.

➤ Bin/transfer screen display part

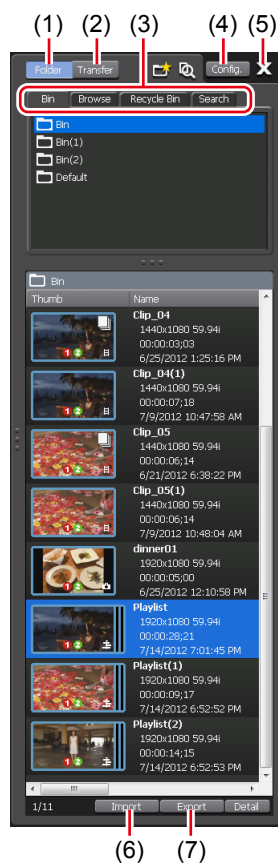

(1)	[Folder]	Displays the bin view ([Bin] tab, [Browse] tab, [Recycle Bin] tab, and [Search] tab).
(2)	[Transfer]	Displays the transfer screen. Transfer screen ▶ P168
(3)	View switching tab	Switches to [Bin] tab/[Browse] tab/[Recycle Bin] tab/[Search] tab. [Bin] tab ▶ P164 [Browse] tab ▶ P165 [Recycle Bin] tab ▶ P166 [Search] tab ▶ P167
(4)	[Config.]	Displays the setting screen.
(5)	[X]	Exits or restarts T2.
(6)	[Import]	Displays the menu related to import. The display switches to the [Browse] tab. Import menu ▶ P168

(7)	[Export]	Displays the menu related to export. The display switches to the [Bin] tab. Export menu►P169
-----	-----------------	---

➤ **[Bin] tab**



(1)	[New Bin]	Creates a new bin.
(2)	[Search Contents]	You can search contents in the bin. Searching for contents►P179
(3)	Bin list	Displays the list of bins. The selected bin is highlighted in blue. Right-clicking the selected bin displays the related menu.
(4)	Contents list	Displays the list of contents selected in the bin list. The selected item is highlighted in blue. Right-clicking the selected contents displays the related menu.
(5)	[Detail]	Displays the details of the contents selected in the contents list.

➤ [Browse] tab

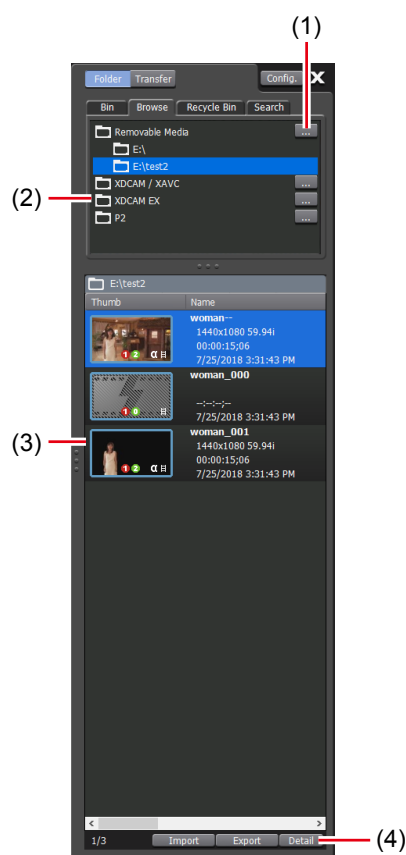

(1)	[...]	When a removable media is connected to T2, you can select a folder to display in the [Browse] tab.
(2)	Removable media list	Displays the removable media's media or folders in the drive connected to T2. The selected folder is highlighted in blue. Right-clicking the selected folder displays the related menu.
(3)	Media file list	Displays the list of media files in the drive selected from the removable media list. The selected media file is highlighted in blue. Right-clicking the selected media file displays the related menu.
(4)	[Detail]	Displays the details of the media file selected in the media file list.

➤ [Recycle Bin] tab

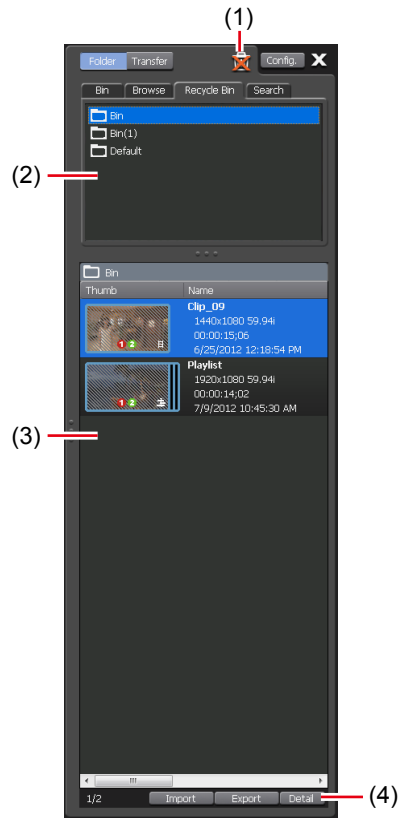

(1)	[Empty Recycle Bin]	Deletes all files in the recycle bin. Note that the deleted contents cannot be restored.
(2)	Recycle bin folder list	Displays the list of folders in the recycle bin. The selected folder is highlighted in blue. Right-clicking the selected folder displays the related menu.
(3)	Contents list	Displays the list of contents in the folder selected in the recycle bin folder list. The selected item is highlighted in blue. Right-clicking the selected contents displays the related menu.
(4)	[Detail]	Displays the details of the contents selected in the contents list.

➤ [Search] tab

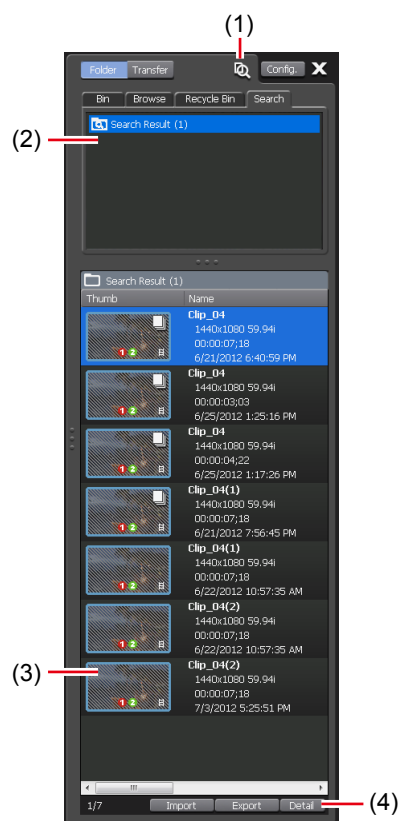

(1)	[Search Contents]	You can search contents in the bin. Searching for contents►P179
(2)	Search result folder list	Displays the list of folders of the search result. The selected folder is highlighted in blue. Right-clicking the selected folder displays the related menu.
(3)	Contents list	Displays the list of contents in the folder selected in the search result folder list. The selected item is highlighted in blue. Right-clicking the selected contents displays the related menu.
(4)	[Detail]	Displays the details of the contents selected in the contents list.

➤ Transfer screen

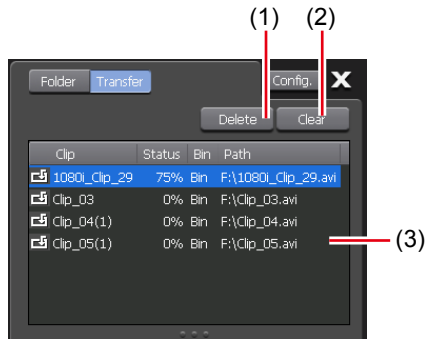

(1)	[Delete]	Deletes selected jobs. If you click [Delete] while executing a job, the job will be canceled.
(2)	[Clear]	Deletes all jobs from the job list.
(3)	Job list	<p>Displays the list of jobs.</p> <p>[Clip] Indicates the name of the clip.</p> <p>[Status] Indicates the job progress status.</p> <p>[Bin] Indicates the bin name.</p> <p>[Path] Indicates media file path and file name.</p>

➤ Import menu

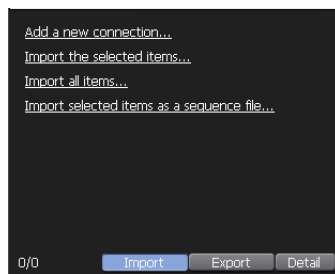

[Add a new connection...]	When a removable media is connected to T2, you can select a folder to display in the [Browse] tab by clicking it.
[Import the selected items...]	Imports the media file selected in the media file list to T2 as a clip.

[Import all items...]	Imports all the media files in the folder selected from the removable media list.
[Import selected items as a sequence file...]	Imports still images with numbers that are serial to the selected still image as a single sequence clip (in Grass Valley HQX AVI).

➤ **Export menu**

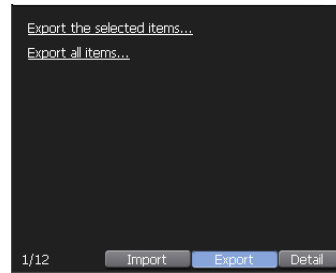

[Export the selected items...]	Exports the selected contents as media files or T2 format (TWF) files.
[Export all items...]	Exports the all items in the selected folder as media files or T2 format (TWF) files.

Keyboard and mouse operations in workstation mode

Multiple selection of contents

You can select multiple contents in the media file list, contents list, event list, and marker list in the same way as PC operations.

Use the [Ctrl] key or [Shift] key on the keyboard or drag the mouse to select multiple contents and perform operations from the right-click menu.

In the event list, you can change the event order by the drag & drop operation with a mouse. You can also sort the multiple events you selected.

Loading contents to Player channel by drag & drop operation

You can quickly load contents in the media file list and contents list to the Player channel by drag & drop operation with a mouse.

- 1 Select contents and drag & drop it to the display area of the Player channel.

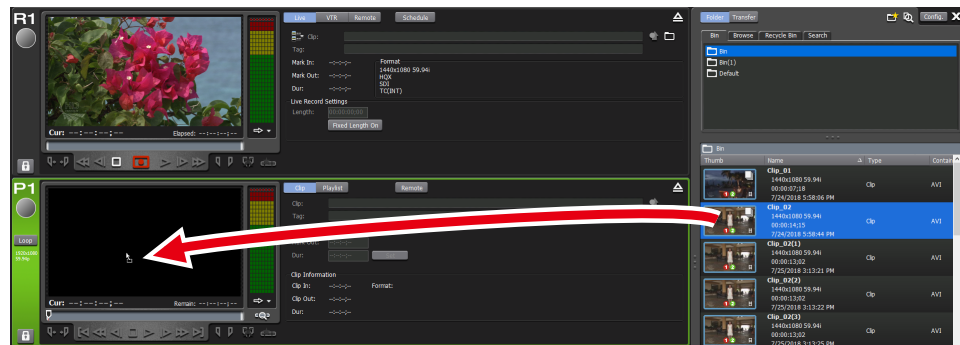

Adding events to playlist by drag & drop operation

You can quickly add events to the playlist by drag & drop operation with a mouse.

You can also add the playlist to another playlist as an event without spreading it out.

- 1 Select contents and drag & drop to the event list.

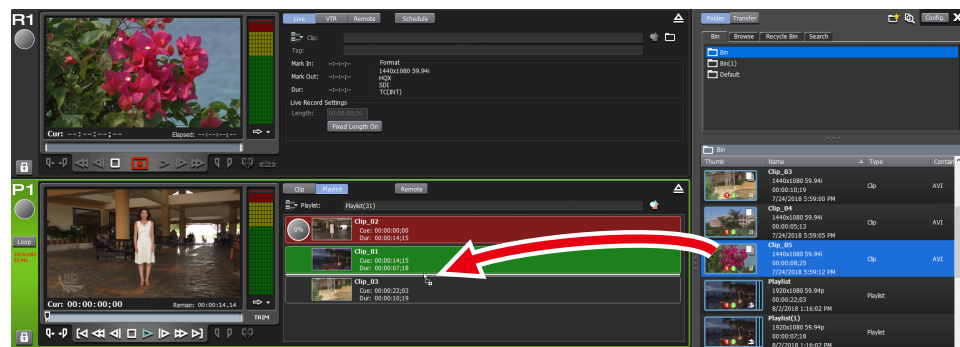

The contents are added to the dropped position as an event.

Sorting events in playlist by drag & drop operation

You can quickly sort events in the playlist by drag & drop operation with a mouse.

- 1 Select an event in the event list and drag & drop to the destination.

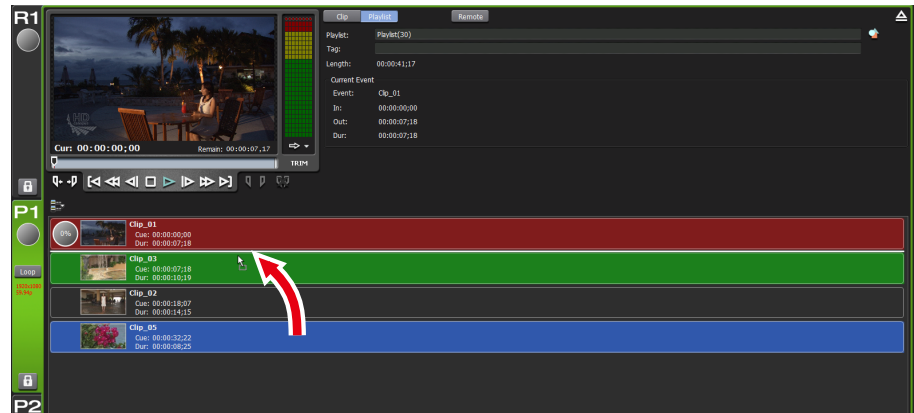

Replacing place holder by drag & drop operation

You can quickly replace place holders by drag & drop operation with a mouse. You can replace a place holder when  is highlighted in red.

- 1 Select an event from the event list, and drag & drop it on the place holder.

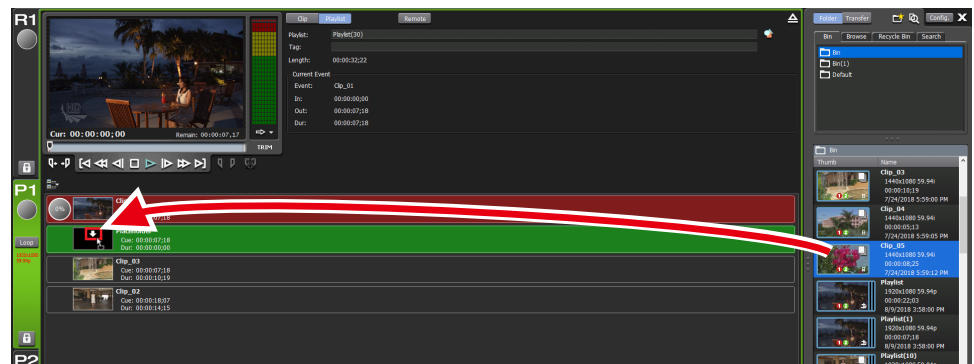

TIP • If the playlist view is set to the detail view, a place holder cannot be replaced by drag & drop.

Major keyboard shortcuts

The following illustration shows the allocation of frequently used keyboard shortcut keys (default).

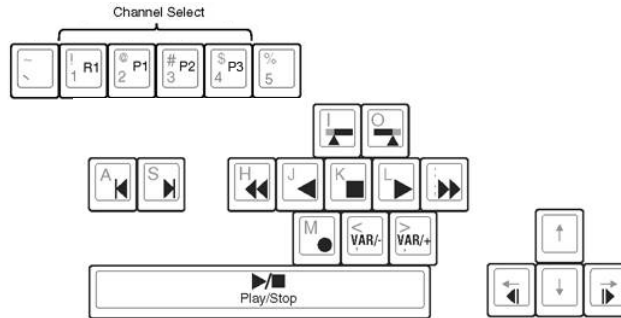

Changing keyboard shortcut assignment

You can customize the shortcuts assigned to the keyboard. The procedure to make a new keyboard shortcut setting based on the default keyboard shortcut to change the shortcut key assignment is described in this part.

- 1 Click [Option] on the menu bar, and then click [Customize] -> [Keyboard Shortcuts...].

➤ [Keyboard Shortcuts] dialog box

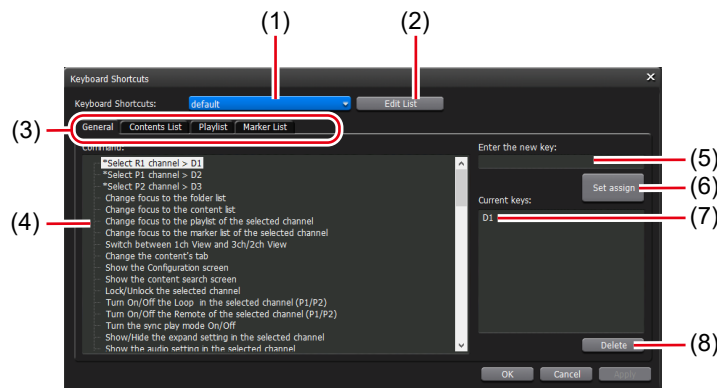

(1)	[Keyboard Shortcuts:]	Selects a keyboard shortcut to use. The default name is "default".
(2)	[Edit List]	Displays the [Edit List] dialog box and allows to change the keyboard shortcut settings in the items of new creation/copy/delete/name.

(3)	Action category switching tab	Switches the action category ([General] tab/[Contents List] tab/[Playlist] tab/[Marker List] tab).
(4)	[Command:]	Displays the list of actions of the selected category.
(5)	[Enter the new key:]	Enter a new shortcut key to assign to the selected command.
(6)	[Set assign]	Assigns the shortcut key entered in [Enter the new key:].
(7)	[Current keys:]	Displays the shortcut key assigned to the selected command.
(8)	[Delete]	Deletes the shortcut key selected in [Current keys:].

- 2** Click [Edit List].
- 3** In the [Edit List] dialog box, click [New...].
- 4** Enter a name of a keyboard shortcut and click [OK].
- 5** In the [Edit List] dialog box, click [Close].
- 6** Select the added shortcut setting from the list of [Keyboard Shortcuts:] in the [Keyboard Shortcuts] dialog box.
- 7** Select a category from the action category switching tab.
- 8** Select an action with [Command:].
- 9** Enter the shortcut key to assign in the entry area of [Enter the new key:] and click [Set assign].
The entered shortcut key is displayed in [Current keys:].
- 10** Click [OK].
Click [Apply] to keep on making settings of other items.

Assigning commands to mouse operation

You can assign commands so that certain mouse operations performs certain actions, such as loading a clip on the Player channel and playing it. The procedure to create a new setting for mouse and assign the command to the mouse is described in this part.

- 1 Click [Option] on the menu bar, and then click [Customize] -> [Mouse...].

➤ [Mouse Customize] dialog box

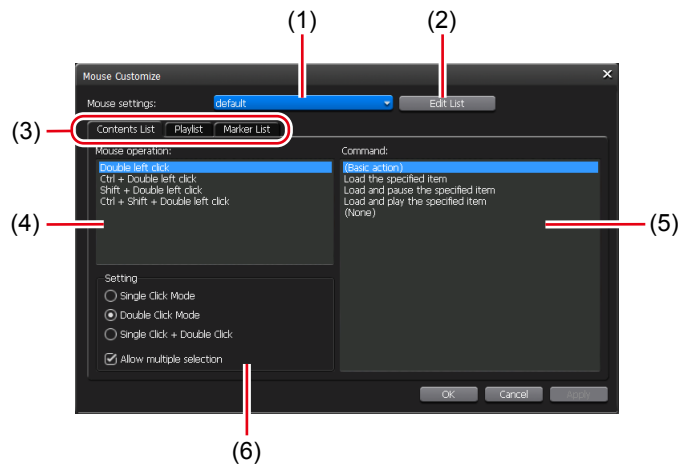

(1)	[Mouse settings:]	Selects a mouse setting to use.
(2)	[Edit List]	Displays the [Edit List] dialog box and allows to change the mouse settings in the items of new creation/copy/delete/name.
(3)	Action category switching tab	Switches the action category ([Contents List] tab/[Playlist] tab/[Marker List] tab).
(4)	[Mouse operation:]	Displays the list of mouse operations of the operation mode selected in [Setting]. Select a mouse operation to assign a command.
(5)	[Command:]	Displays the list of actions of the selected category. Select a command to assign to the mouse operation selected in [Mouse operation:].

(6)	[Setting]	Selects the operation mode of mouse from [Single Click Mode], [Double Click Mode], and [Single Click + Double Click]. Checking [Allow multiple selection] allows multiple selections of contents by the mouse operation.
------------	------------------	---

- 2** Click [Edit List].
 - 3** In the [Edit List] dialog box, click [New...].
 - 4** Enter the name of the mouse setting and click [OK].
 - 5** In the [Edit List] dialog box, click [Close].
 - 6** Select the added mouse setting from the list of [Mouse settings:] in the [Mouse Customize] dialog box.
 - 7** Select the operation mode of mouse in [Setting].
 - 8** Select a mouse operation to assign a command in [Mouse operation:].
 - 9** Select an action with [Command:].
 - 10** Click [OK].
- Click [Apply] to keep on making settings of other items.

Recording sources at once (batch capturing)

You can import the batch capture list to your T2 and record sources from VTR at once.

The batch capture lists in the following file formats can be imported.

- CSV file (Mode1/Mode2) (*.csv): Batch capture list created with EDIUS
- ALE file (*.ale): File corresponding to Avid Log Exchange batch capture list
- FCL file (*.fcl): File corresponding to Apple Final Cut Pro batch capture list

NOTE • After importing the batch capture list to your T2, you cannot change In/Out points, duration, or reel name, and you cannot add batch capture items.

Set the connection information of the VTR used for action setting of batch capturing and for recording, or the video format for capturing beforehand.

General – Hardware settings ▶ P189

Recorder settings ▶ P207

Transfer – common settings ▶ P219

Make settings in the setting screen according to the environment in use.

Settings ▶ P188

The procedure to import a batch capture list and start recording is described in this part.

1 Click the Recorder channel tab.

Recorder channel is selected.

Recorder channel – 2ch/3ch view ▶ P135

2 Click [VTR].

The mode switches to the Recorder-VTR mode.

3 Click [Batch].

The mode switches to the Recorder-VTR batch mode.

4 Click [Load Batch Capture List].

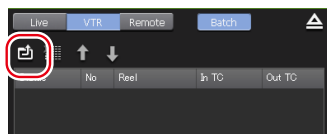

5 Select the batch capture list and click [OK].

The batch capture list appears.

➤ Recorder-VTR batch mode

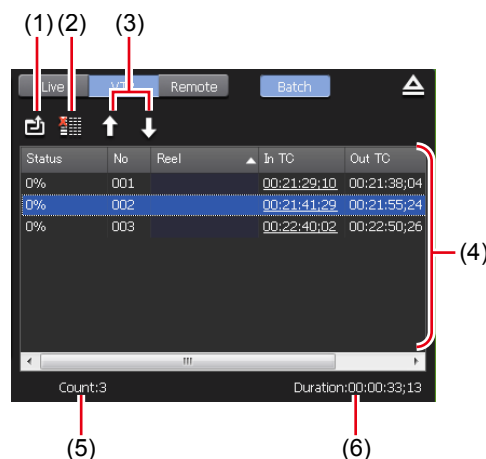

(1)	[Load Batch Capture List]	Imports the batch capture list (CSV, ALE, FCL files).
(2)	[Delete Batch Capture Item]	Deletes a batch capture item. You can also perform the same operation by selecting and right-clicking an item, and then clicking [Delete].
(3)	[Move Up]/ [Move Down]	Sorts the batch capture items. Selecting an item and clicking [Move Up] or [Move Down] moves an item up or down by one line. You can also perform the same operation by selecting and right-clicking an item, and then clicking [Move Up] or [Move Down].
(4)	Batch capture list	[Status] Displays the recording progress. When an error occurs, displays the error detail. [No] Displays the serial number corresponding to the suffix of the clip name generated after the batch capture. [Reel] Displays the reel name.

(4)	Batch capture list	<p>[In TC]/[Out TC]/[Dur TC] Displays the timecode of In point/Out point/duration. The timecode to be prioritized when recording is underlined. To change the prioritized timecode, select and right-click an item, and then click [Change to "In/Out Capture"] or [Change to "In/Dur Capture"].</p>
(5)	[Count:]	Displays the total number of the batch capture items.
(6)	[Duration:]	Displays the total duration in the batch capture list.

TIP • Select and right-click an batch capture item, and then click [Select All] to select all items.

6 Press the [Rec] button.

If batch capture items with different reel names set exist in the batch capture list, a message appears. Insert a tape corresponding to the reel name into the VTR and click [OK]. (If the same reel names are set in all batch capture items, or if no reel name is set, the message will not appear and recording starts.)

Recording starts and the progress is displayed in [Status].

If you stop the batch capture in the middle, click [Stop].

Clips that have been completed recording are stored in the specified bin.

Displaying media files in network drive

You can display media files in the network drive at the [Browse] tab by making settings of the network drive connected to T2 in the workstation mode.

1 Click [Config.], and click the [General] -> [Network-3] tab.

General – Network-3 settings ▶ P196

2 Click [Add...].

The [Map Network Drive] dialog box appears.

3 Assign a drive letter to [Drive:].

4 In the [Folder:] entry area, enter the “server name and shared folder” or “IP address and shared folder”, and then click [OK].

You can click [Browse...] to specify the path of the network drive.

- 5 Click [OK].
- 6 Display the [Browse] tab.

[Browse] tab ▶ P165

The drive letter assigned in step 3 is displayed in the removable media list.

- 7 Click [...] at the right of the drive letter, and select a folder in the network drive, and then click [OK].

The contents in the network drive are displayed in the media file list.

TIP

- To save the specified recording destination on the external media/storage after restarting T2, click [Config.], click [General] -> [Miscellaneous] tab, and then check [Keep the connections on the browse tab].

Searching for contents

You can specify search conditions and search for contents in the bin.

- 1 Click [Search Contents].

This operation is available in the [Bin] tab or [Search] tab.

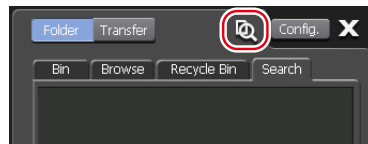

➤ [Search] dialog box

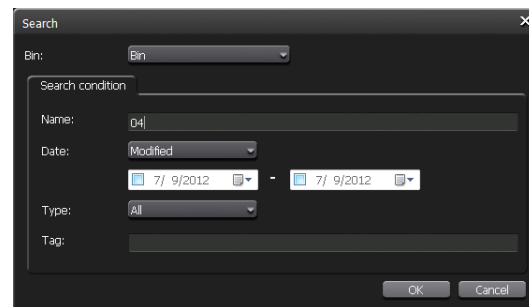

[Bin:]	Select the search target bin from the list.
---------------	---

<p>[Search condition]</p>	<p>Specify search conditions. If multiple conditions are specified, AND search will be performed.</p> <p>[Name:] Enter the contents name to search.</p> <p>[Date:] Select [Modified] or [Created], click the icon on the calendar, and set the date.</p> <p>[Type:] Select [all], [SD], [HD] or [4K] from the list.</p> <p>[Tag:] Enter the tag added to the contents.</p>
----------------------------------	--

2 Select a search target bin from the list of [Bin:].

3 Specify search conditions and click [OK].

The search starts.

The contents that matches the search conditions are displayed in the contents list in the search result folder of the [Search] tab.

[Search] tab ▶ P167

TIP

- To change the search conditions, right-click the search result folder and click [Change Search Criteria...].
- To delete the search result folder, right-click the search result folder and click [Clear].
- To change the name of the search result folder, right-click the search result folder and click [Rename].

Changing the playlist type

You can change the playlist type. In a playlist in the normal format, each events are added without creating spaces. In a playlist in the timeline format, events can be added to a desired position on the timeline by specifying the timecode.

1 Right-click on the playlist in the bin and click [Properties].

2 Click [Change...]

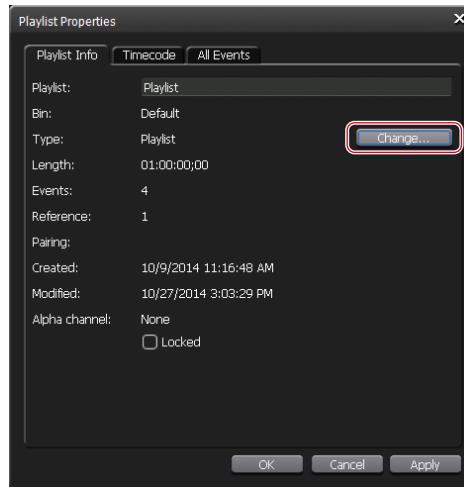

➤ [Playlist type] dialog box

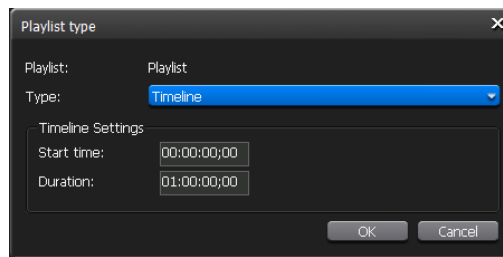

(1)	[Playlist:]	Indicates the name of the loaded playlist.
(2)	[Type:]	<p>Selects the playlist type from the list.</p> <p>[Playlist] Playlist in the normal format. You can add clips, playlists, and placeholders. Added events can be placed without spaces between other events. Editing a playlist ▶ P110</p> <p>[Timeline] Playlist in the timeline format. You can set the start timecode or duration of playlists and place clips at desired positions by specifying the timecode. Events that can be added are clips only. The spaces between events are registered as gap events, and a black screen is output during gap event playback.</p>

(3)	Timeline Settings	<p>Set the timeline settings.</p> <p>[Start time:] Set start time of playlist.</p> <p>[Duration:] Set duration of playlist. A duration cannot be set when the duration is shorter than the total duration of all events.</p>
-----	--------------------------	--

3 Select a playlist type in list of [Type:].

- TIP**
- Playlist which are added place holder or playlist event cannot be changed to timeline.
 - Playlist duration cannot be set when the duration is shorter than the total duration of all events.
 - When timeline playlist change to playlist, the gap events are change to the place holders.

4 Click [OK].

The playlist type is confirmed on the playlist view or properties.

Player channel (playlist view) – 2ch/3ch view ▶ P155

Editing playlist in the timeline format

Adding, deleting, and moving events on the playlist in the timeline format can be performed only in the workstation mode. Performing playback and applying effects can be operated also on the front panel.

Editing a playlist ▶ P110

Adding events to playlist by drag & drop operation ▶ P170

Sorting events in playlist by drag & drop operation ▶ P171

Creating playlist in the timeline format

After creating a playlist in the normal format, the playlist type can be changed to the timeline format.

Changing the playlist type ▶ P180

A playlist that includes clip events and gap events added before changing the format will be created. The duration of the gap event is determined automatically by the difference between the duration of the playlist and clip event.

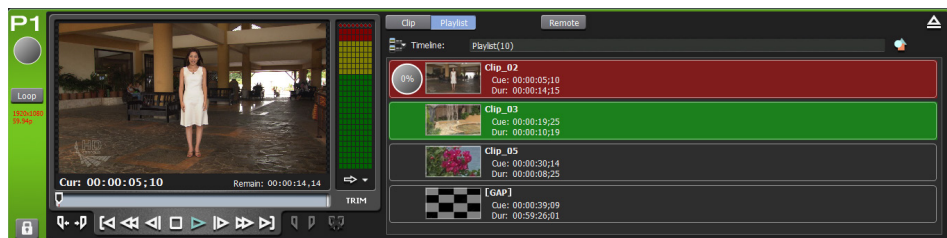

Adding event to playlist in the timeline format

- 1 Show the playlist view of timeline playlist.
- 2 Select events in the bin and then load contents to the playlist by drag & drop operation.

Adding events to playlist by drag & drop operation ► P170

► [Set start Timecode of Event] dialog box

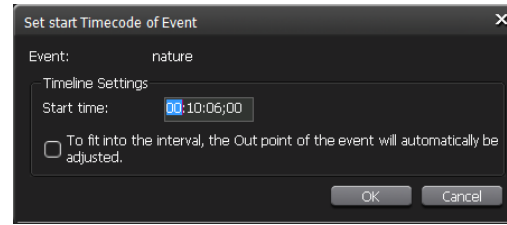

(1)	[Event:]	Indicates the name of the loaded event.
(2)	[Timeline settings]	<p>Sets the position and length of an event to be added.</p> <p>[Start time] Enter the start timecode where an event is to be added. You cannot add an event if this is indicated in red.</p> <p>[To fit into the interval, the Out point of the event will automatically be adjusted] By checking this item, adds an event by automatically trimming at the Out point if the Out point of the clip to be added comes later than the playlist duration.</p>

TIP

- A gap event is added automatically on the timecode where an event is not placed.
- An event cannot be added if In and Out points of the event to be added do not exist within the playlist timeline.
- An event cannot be added if it overlaps with an event other than a gap event that has already been added.

- 3 Specify the starting timecode of an event and click [OK].

The event is added. A gap event is added automatically on the timecode where an event is not placed.

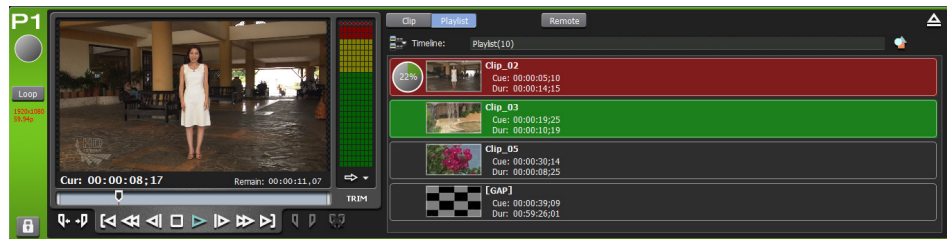

Changing starting timecode of an event

You can change the start timecode of an event that is added to a playlist in the timeline format.

- 1 On the playlist view, right-click on the event whose start timecode is to be changed, and click [Set Start Timecode...].
- 2 Set the start timecode in [Set start Timecode of Event] dialog box.

[Set start Timecode of Event] dialog box ► P183

TIP • An event cannot be added if it overlaps with an event other than a gap event that has already been added.

- 3 Click [OK].

Deleting event from playlist in the timeline format

You can delete events from playlists in the timeline format. Gap events cannot be deleted.

- 1 Right-click on the event in the playlist view and click [Delete].
- 2 Click [OK].

Changing the display of playlist view

Changing the display of event list

You can switch the display of event list to the icon view or list view without thumbnail.

- 1 Right-click on the event list and click [View] -> the display option ([Icons]/[Tiles]/[List]/[Details]).

TIP

- If keyboard shortcuts are assigned to events and one of [Icons]/[Tiles]/[List] is selected for the view, an icon is displayed on the thumbnail.
 - A red icon indicates the shortcut assigned to the event of the selected channel.
 - A black icon indicates the shortcut assigned to the event of the specified channel.
- If one of [Icons]/[Tiles]/[List] is selected for the view, you can change the display size of the thumbnail. Right-click on the event list and click [View] -> [Thumbnail Size] -> the display size ([Large]/[Middle]/[Small]).

Changing the display or background color of events

You can change the settings of the event view style and background color.

- 1 Right-click on the event list and click [View] -> [Customize...].

The [Playlist View Style:] dialog box appears.

[Playlist View Style:] dialog box (workstation mode only) ► P204

- 2 Configure the settings, and then click [OK].

Checking logs of operations and processes

Displaying a log

You can output logs of operations and processes. Use it to find out the cause of troubles.

- 1 Click [Option] on the menu bar, and then click [Log] -> [Show log...].

➤ [Log] dialog box

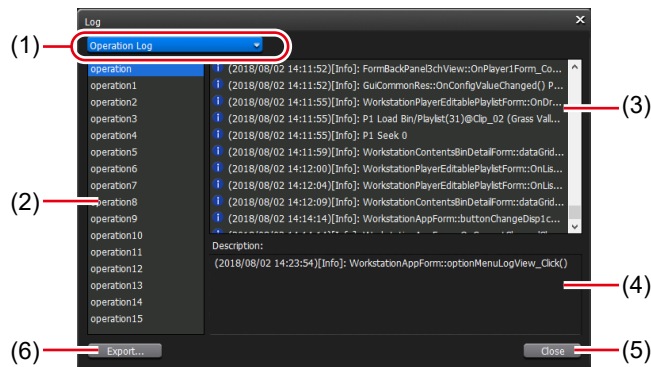

(1)	Output log switching	Selects [Operation Log] to display operation logs, and select [Process Log] to display process logs.
(2)	Group list	Displays the list of groups for operations or processes. A group is created daily (or when the log data exceeds 10 MB).
(3)	Log list	Displays the log list of the group selected in the group list.
(4)	[Description:]	Displays the explanation for the log selected in the log list.
(5)	[Close]	Closes the dialog box.
(6)	[Export]	Export the logs to external folder which is selected.

TIP • When an error occurs, you can also display the [Log] dialog box by clicking the notification icon on the status bar.

Changing log level settings

You can change the output log levels of operations and processes. By the default setting, information, warning, and error will be output.

- 1 Click [Option] on the menu bar, and then click [Log] -> [Logging level...].

➤ [Log Level Setting] dialog box

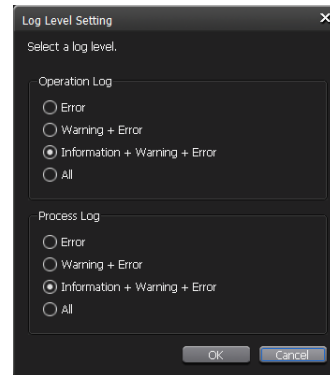

<p>[Operation Log]</p>	<p>Selects the type of operation log to output.</p> <p>[Error] Outputs only error logs.</p> <p>[Warning + Error] Outputs warning and error logs.</p> <p>[Information + Warning + Error] Outputs information, warning, and error logs.</p> <p>[All] Outputs all logs including debug information.</p>
<p>[Process Log]</p>	<p>Selects the type of process log to output.</p> <p>[Error] Outputs only error logs.</p> <p>[Warning + Error] Outputs warning and error logs.</p> <p>[Information + Warning + Error] Outputs information, warning, and error logs.</p> <p>[All] Outputs all logs including debug information.</p>

- 2 Configure the settings, and then click [OK].

Settings

This section describes items that you can set in the setting screen.

Displaying the setting screen

You can make settings in the setting screen.

1 Tap [Config.].

The configuration screen appears.

➤ Settings

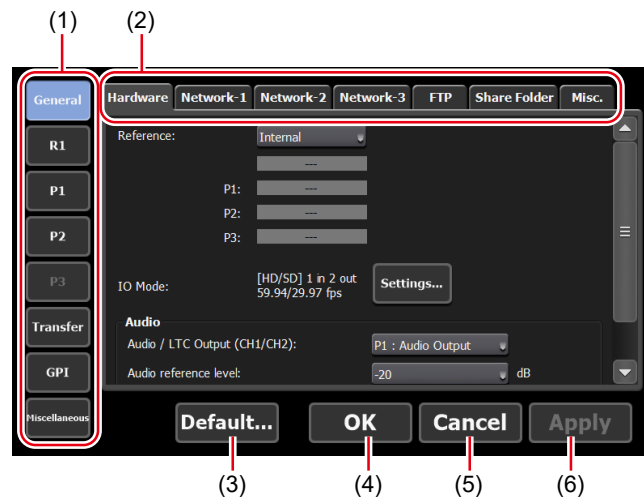

(1)	Main category	Switches the main category of each setting. By tapping, displays the sub category tabs included in the main category.
(2)	Sub category tab	By tapping, displays the detailed settings of the sub category.
(3)	[Default...]	Restores all the settings made in the setting screen to the default. To enable the settings, you must restart your T2.
(4)	[OK]	Saves the current settings and closes the setting screen.

(5)	[Cancel]	Closes the setting screen without saving the current settings.
(6)	[Apply]	Saves the current settings. You can keep on making settings of other items.

General settings

General – Hardware settings

You can set synchronization or audio level between an external device connected to your T2.

- 1 Tap [General], and then tap the [Hardware] tab in the setting screen.

➤ [Hardware] tab

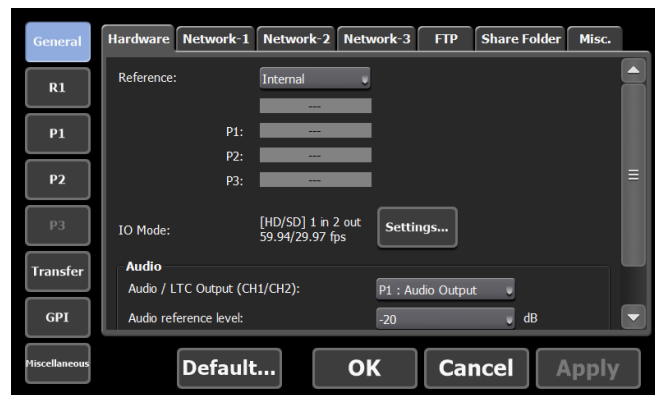

[Reference:]

Selects a sync signal from [External], [Input], and [Internal].

The signal status (NO SIGNAL/SYNC OK) will be displayed in the lower line.

[P1:]

If the sync signal has been synchronized with the P1 channel, displays [SYNC OK].

[P2:]

If the sync signal has been synchronized with the P2 channel, displays [SYNC OK].

[P3:]*1

If the sync signal has been synchronized with the P3 channel, displays [SYNC OK].

[IO Mode]

By clicking [Settings...], selects an IO mode and frame rate.

[IO Mode Setting] dialog box ▶ P191

<p>[Audio / LTC Output (CH1/CH2):]</p>	<p>Sets the output details from the AUDIO / LTC OUT connector on the rear panel.</p> <p>[P1:Audio Output] Outputs the audio signal L of P1 channel from CH1, and the audio signal R from CH2.</p> <p>[P2:Audio Output] Outputs the audio signal L of P2 channel from CH1, and the audio signal R from CH2.</p> <p>[P3:Audio Output]*1 Outputs the audio signal L of P3 channel from CH1, and the audio signal R from CH2.</p> <p>[R1:Audio Output] Outputs the audio signal L of R1 channel from CH1, and the audio signal R from CH2.</p> <p>[P1/P2:LTC Output] Outputs the LTC of P1 channel from CH1, and the LTC of P2 channel from CH2.</p> <p>[P1/P3:LTC Output]*1 Outputs the LTC of P1 channel from CH1, and the LTC of P3 channel from CH2.</p> <p>[P2/P3:LTC Output]*1 Outputs the LTC of P2 channel from CH1, and the LTC of P3 channel from CH2.</p> <p>Audio level detail display (Recorder channel) ► P147</p> <p>Audio level detail display (Player channel) ► P160</p>
<p>[Audio reference level:]</p>	<p>Selects the audio reference level (Headroom) from the list.</p>
<p>[ASIO audio device:]*2</p>	<p>Click [Settings...], and configure the settings for the ASIO audio device.</p> <p>[ASIO audio device] dialog box (workstation mode only) ► P194</p> <p>Utilizing ASIO audio device ► P243</p>

*1 Settings for P3 channel are only available on a model that can use P3 channel.

*2 This setting is only available in the workstation mode.

➤ [IO Mode Setting] dialog box

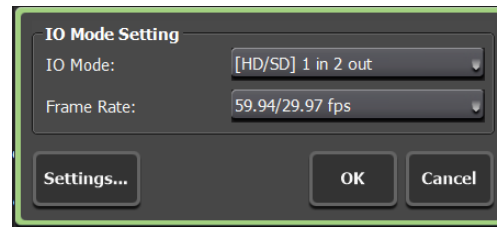

[IO Mode:]	Selects an IO mode option. IO mode list▶P263
[Frame Rate:]	Selects a frame rate. <ul style="list-style-type: none"> • [59.94/29.97 fps]: Either of 59.94p, 29.97p, and 59.94i • [50/25 fps]: Either of 50p, 25p, and 50i • [24 fps]: Either of 24p and 24PsF • [23.98 fps]: Either of 23.98p and 23.98PsF
[Settings...]	By tapping, displays the dialog box for IO mode detailed settings to enable advanced settings regarding the selected IO mode. IO mode detailed settings dialog box▶P191

➤ IO mode detailed settings dialog box

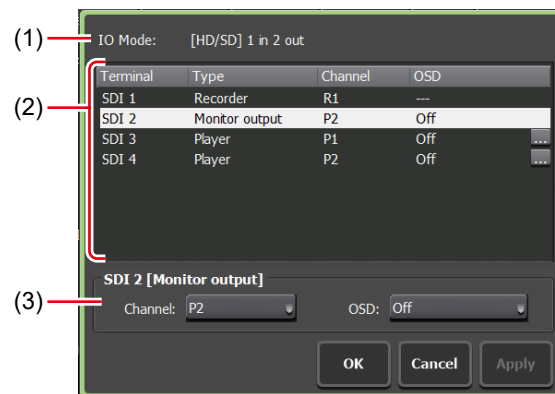

(1)	[IO Mode:]	Indicates the IO mode to be configured.
-----	------------	---

(2)	List of SDI terminal setting	<p>Displays a list of settings assigned to the SDI terminals on the video I/O board.</p> <p>[Terminal] Indicates the terminal name.</p> <p>[Type] Indicates the type.</p> <ul style="list-style-type: none"> • [Recorder] indicates a terminal assigned to Recorder. • [Player] indicates a terminal assigned to Player. • [Monitor output] indicates a terminal that can be used for monitor output. • [(Not Available)] indicates a terminal that cannot be used. <p>[Channel] Indicates the channel assigned to the SDI terminal or the channel set for monitor output.</p> <p>[OSD] Displays the settings for on-screen display. If [Player] is indicated for [Type], tapping [...] allows to set the contents shown on the on-screen display.</p> <p>On-screen display detailed settings dialog box ▶ P106</p>
(3)	[Channel:]/ [OSD:]	<p>Allows to change the setting of a terminal selected from the list of SDI terminal setting. The items that can be configured differ depending on the terminal type or channel.</p> <p>Terminal types and available settings ▶ P192</p>

➤ **Terminal types and available settings**

Terminal type	Settings available for [Channel:]	Settings available for [OSD:]
Recorder	The channel setting for the Recorder terminal cannot be changed. The preset Recorder channel will be displayed.	On-screen display is not available on Recorder channel.

Terminal type	Settings available for [Channel:]	Settings available for [OSD:]
Player	<p>The channel setting for the Player terminal cannot be changed.</p> <p>The preset Player channel will be displayed.</p>	<p>Select the setting of indication for on-screen display on the Player channel.</p> <p>[Off] Does not show on-screen display on the Player channel.</p> <p>[Both] Shows on-screen display both on the Player channel preview of the T2 screen and on the output video from the SDI terminal.</p> <p>[PC Preview only] Shows on-screen display only on the Player channel preview of the T2 screen. On-screen display is not shown on the output video from the SDI terminal.</p>
Monitor output	<p>Select Recorder channel^{*1} or Player channel as an output channel from the monitor output terminal.</p>	<p>[Off] Does not show on-screen display on the output video from the SDI terminal.</p> <p>[On] Shows on-screen display on the output video from the SDI terminal. Displays the same contents as those of the on-screen display detailed settings for the Player channel that has been set for [Channel:].</p>

*1 For monitor output of Recorder channel, prior setting is necessary. Go to the setting screen, [General] -> [Hardware] tab, and select [Input] for [Reference:]. If [External] or [Internal] has been selected, output video cannot be displayed properly.

General – Hardware settings ► P189

➤ **[ASIO audio device] dialog box (workstation mode only)**

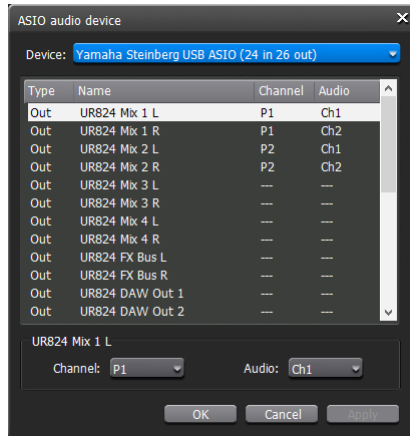

[Device:]	Selects the ASIO audio device to use.
Audio terminal list	Displays a list that includes audio device terminals and the audio channels assigned to each of the terminals.
[Channel:]	Sets the channel of the Recorder or Player to be assigned.
[Audio:]	Sets the audio channel to be assigned.

2 Set each item and tap [OK].

Tap [Apply] to keep on making settings of other items.

General – Network-1/Network-2 settings

You can make network settings of your T2.

1 Tap [General], and then tap the [Network-1] tab or [Network-2] tab in the setting screen.

➤ [Network-1]/[Network-2] tab

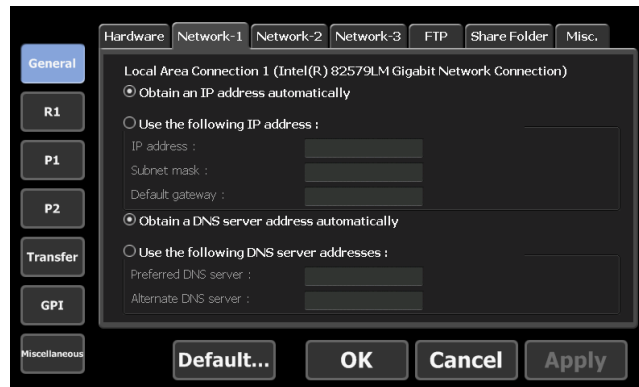

[Obtain an IP address automatically]	Uses DHCP and sets an IP address automatically.
[Use the following IP address:]	Used to connect to the local area network by specifying the IP address, subnet mask, and default gateway. [IP address:] Specifies an IP address. [Subnet mask:] Specifies a subnet mask. [Default gateway:] Specifies a default gateway.
[Obtain a DNS server address automatically]	Uses DHCP and sets a DNS server address automatically.
[Use the following DNS server addresses:]	Used to connect to the local area network by specifying the address of the preferred DNS server and an alternate DNS server. [Preferred DNS server:] Specifies the address of the preferred DNS server. [Alternate DNS server:] Specifies the address of an alternate DNS server.

2 Set each item and tap [OK].

Tap [Apply] to keep on making settings of other items.

General – Network-3 settings

You can set the network drive to connect with your T2.

- 1 Tap [General], and then tap the [Network-3] tab in the setting screen.

➤ [Network-3] tab

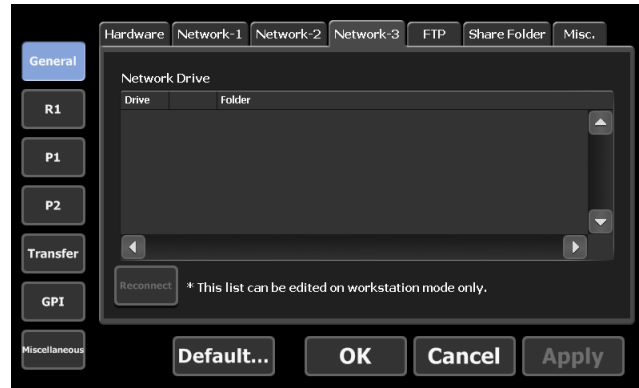

Network drive list	Displays the list of currently set network drives.
[Add...]*	By clicking, displays the [Map Network Drive] dialog box and adds a network drive. [Map Network Drive] dialog box (workstation mode only) ► P196
[Disconnect]*	Disconnects the network drive.
[Reconnect]	Reconnects the network drive that is in disconnected status.

* Only available in the workstation mode.

➤ [Map Network Drive] dialog box (workstation mode only)

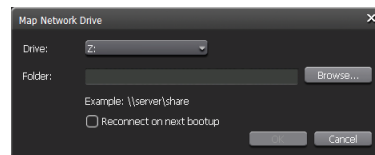

[Drive:]	Assigns a drive letter to a network drive.
[Folder:]	Enter the “server name and shared folder” or “IP address and shared folder” in the entry area. You can click [Browse...] to specify the path of the network drive.
[Reconnect on next bootup]	By checking, restores the network drive allocations on the next start-up of T2.

2 Set each item and tap [OK].

Tap [Apply] to keep on making settings of other items.

General – FTP settings

You can configure FTP settings when T2 is used as FTP server, or the destination when external FTP server is used for a file transfer destination.

1 Tap [General], and then tap the [FTP] tab in the setting screen.

➤ [FTP] tab

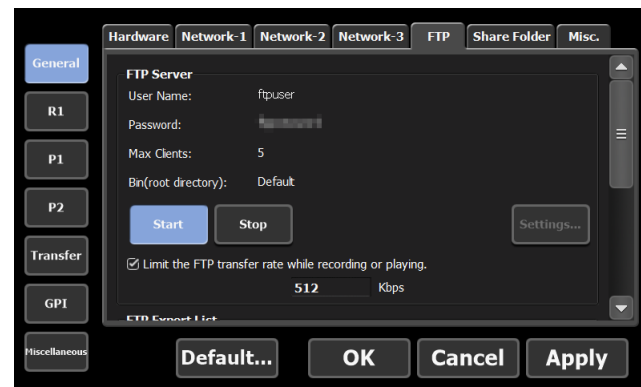

Displays the FTP settings when T2 is used as FTP server.

[Settings...]

By tapping, configures FTP settings for T2.

Tapping it displays the FTP setting dialog box for T2 to configure the settings.

FTP setting dialog box for T2 ▶ P198

[Start]

Sets and uses T2 as FTP server.

[Stop]

Releases the setting and stops using T2 as FTP server.

[Limit the FTP transfer rate while recording or playing.]

By checking, automatically restricts FTP transfer rate while recording or playing. Tapping the entry area allows to change the limit value of the transfer rate. Different limit values can be specified for uploading and downloading, and when uploading and downloading are performed simultaneously, the transfer rate will be the double of the set value.

If this option is unchecked, the recording/playback operations may not be performed normally, therefore, we recommend that you use the system with this option checked.

[FTP Server]

<p>[FTP Export List]</p>	<p>Displays the list of the FTP servers set as file transfer destinations.</p> <p>[Add...] Tapping it displays the FTP destination setting dialog box to configure the destination server. FTP destination setting dialog box▶P198</p> <p>[Delete] Deletes a server from [FTP Export List].</p> <p>[Change...] Changes the server settings.</p>
---------------------------------	---

➤ **FTP setting dialog box for T2**

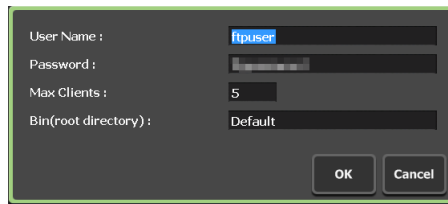

<p>[User Name:]/ [Password:]</p>	<p>Enter a user name and password.</p>
<p>[Max Clients:]</p>	<p>Specifies the maximum number of users allowed to access the FTP server of T2.</p>
<p>[Bin(root directory):]</p>	<p>Specifies the bin to store media files uploaded to the root directory.</p>

➤ **FTP destination setting dialog box**

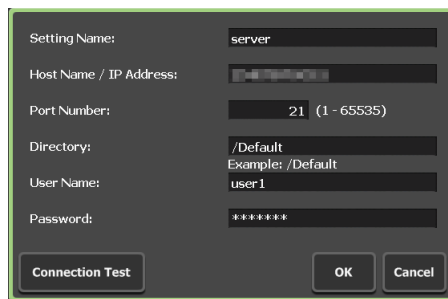

<p>[Setting Name:]</p>	<p>Enter the server setting name.</p>
<p>[Host Name/IP Address:]</p>	<p>Enter the IP address or host name of the FTP server.</p>

[Port Number:]	Enter a port number (1 to 65535).
[Directory:]	Enter the address of file transfer destination folder (bin).
[User Name:]/ [Password:]	Enter a user name and password.
[Connection Test]	By tapping, tests the FTP connection with the entered user name and password.

2 Set each item and tap [OK].

Tap [Apply] to keep on making settings of other items.

General – Share Folder settings

You can make settings for the user account of T2 and shared folders such as WatchFolder, direct access folder, etc.

- TIP**
- If you copy media files to the WatchFolder of the internal storage, recording or playback may be affected.
 - Direct access folder is read only.

1 Tap [General], and then tap the [Share Folder] tab in the setting screen.

➤ [Share Folder] tab

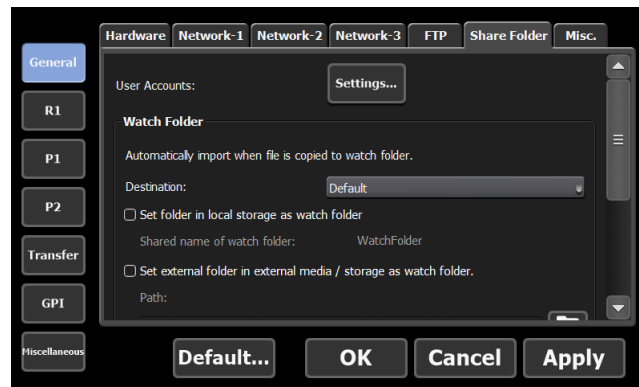

[User Accounts :]

Sets the user account of T2. A user account is required when you access the WatchFolder or direct access folder in the internal storage.

[Settings...]

By tapping this, the dialog box to configure the user account settings of T2 will be displayed. To enable the settings, you must restart your T2.

User Accounts setting dialog box ▶ P201

<p>[Watch Folder]</p>	<p>Monitors the specified WatchFolder and imports media files automatically. To enable the settings, you must restart your T2.</p> <p>Importing a media file on WatchFolder ► P61</p> <p>[Destination :] Selects the saving destination bin for the media files to be imported.</p> <p>[Set folder in local storage as watch folder] By checking, monitors the shared folder of the internal storage as WatchFolder.</p> <p>Indicates the WatchFolder name, and user name and password to access the WatchFolder. To enable the settings, you must restart your T2.</p> <p>[Set external folder in external media / storage as watch folder] By checking, allows to set a folder on an external media or storage as WatchFolder. To enable the settings, you must restart your T2.</p> <p>[Path :] Specifies the folder to monitor as WatchFolder.</p>
<p>[Direct access folder] (T2 4K Elite/T2 4K Elite Plus only)</p>	<p>Directly accesses a media file in the internal storage via Windows common internet file system (CIFS). To enable the settings, you must restart your T2.</p> <p>Directly loading a clip recorded or being recorded (T2 4K Elite/T2 4K Elite Plus only) ► P74</p> <p>[Share a T2 media storage as share folder] By checking this, the internal storage will be set as a shared folder to share the saved media files, which can be accessed from clients. Media files that can be accessed are AVI and MXF only.</p> <p>[Limit the operation(delete, rename) on T2 when using media file] By unchecking this, deleting or renaming of the media files accessed from clients will be enabled on T2.</p>

➤ User Accounts setting dialog box

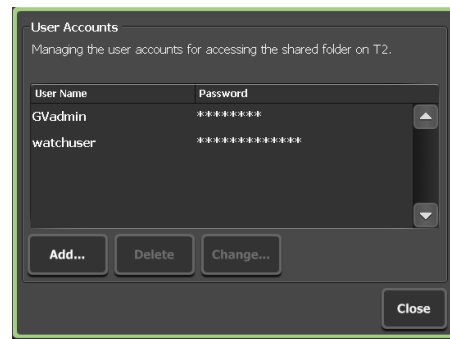

<p>[User Name:]/ [Password:]</p>	<p>Sets the user account. A user account is required when a client access the WatchFolder or direct access folder in the internal storage. You can access all folders in the internal storage using any account.</p> <p>The default user name and password are as follows.</p> <p>(User Name) GVadmin (Password) adminGV! (User Name) watchuser (Password) watchpassword</p>
<p>[Add...]</p>	<p>Add user account.</p>
<p>[Delete]</p>	<p>Deletes a selected user account.</p>
<p>[Change...]</p>	<p>Edit a selected user account.</p>

TIP • The user account setting is enabled after T2 is restarted.

2 Set each item and tap [OK].

Tap [Apply] to keep on making settings of other items.

General – Miscellaneous settings

You can configure display language for T2 software, restart status, or other settings.

- 1 Tap [General], and then tap the [Miscellaneous] tab in the setting screen.

➤ [Miscellaneous] tab

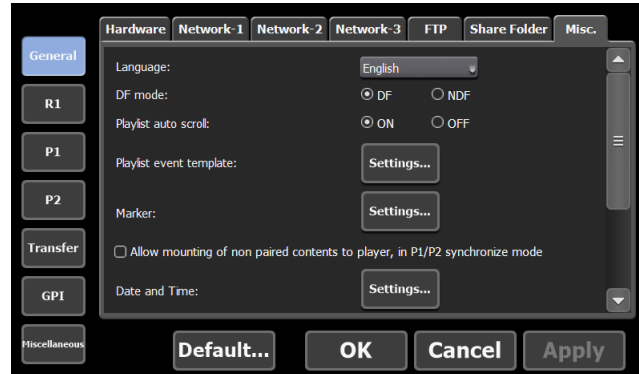

[Language:]	Selects the display language for T2 software from the list. To enable the settings, you must restart your T2.
[DF mode:]	Select [DF] to set drop frame display to timecode, or select [NDF] to set non-drop frame display.
[Playlist auto scroll:]	Sets whether to scroll the event list automatically when playing a playlist.
[Playlist event template:]	By tapping [Settings...], sets the effect as the event template of the playlist. The template setting is applied to newly added events. The event template setting dialog box ▶ P204
[Playlist View Style:]*1	By clicking [Settings...], changes the settings for event display or event background color in the workstation mode. [Playlist View Style:] dialog box (workstation mode only) ▶ P204
[Playlist Placeholder]*1	By clicking [Settings...], configures the settings to secure the space for events to be added to playlists before actually adding an event to a playlist. [Playlist Placeholder] dialog box (workstation mode only) ▶ P205

[Marker :]	By clicking [Settings...], changes the settings for markers. [Marker] dialog box▶P124
[Allow mounting of non paired contents to player, in P1/P2 synchronized mode]	By checking, allows to mount non paired contents while in synchronized mode. When a non paired content is mounted while in synchronized mode, channels that are not mounted are output as black screen. Sync playback of contents (Sync mode)▶P101
[Preview update interval:]*¹	By clicking [Settings...], sets the update interval of preview of the Recorder channel or the Player channel. [Preview update interval:] dialog box (workstation mode only)▶ P206
[Date and Time :]	By tapping [Settings...], sets the date and time. Date and time setting dialog box▶ P206
[Status at the next startup]	Sets whether to restore the status of the time when exiting T2 at the next start-up. [Keep the connections on the browse tab] By checking, restores the removable media connection status displayed in the [Browse] tab. The removable media state displayed in the [Browse] tab will be updated at the next start-up. [Automatically playback the mounted contents on Px] By checking, restores the contents status loaded to the Player channel. By checking [Keep the playback frame positions on Px], restores the scrubbing bar playing position. Checking [Automatically playback the mounted contents on Px] plays the contents loaded to the Player channel automatically at the next start-up. * The names or In/Out points of media files loaded directly from the [Browse] tab cannot be restored.

*1 Only available in the workstation mode.

➤ **The event template setting dialog box**

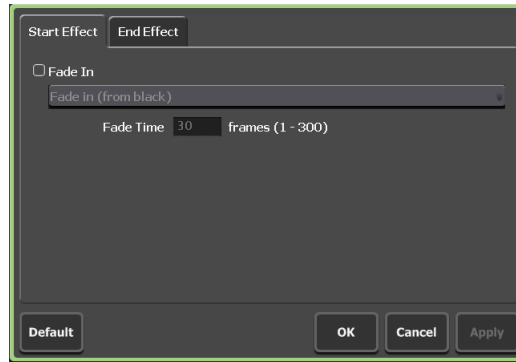

[Start Effect] tab	Sets the effects for event starting (start effects). Event – [Start Effect] tab ► P114
[End Effect] tab	Sets the effects for event ending (end effects). Event – [End Effect] tab ► P115
[Default]	Deletes event template settings.

➤ **[Playlist View Style:] dialog box (workstation mode only)**

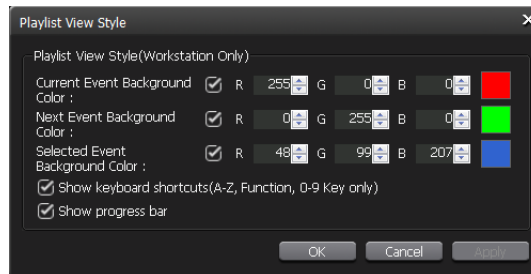

[Current Event Background Color:]	Sets to show/hide the background color indicating that the event has the playback position on the scrubbing bar. To change the background color, check this item and specify the value for R, G, and B. The specified color is displayed on the right.
[Next Event Background Color]	Sets to show/hide the background color indicating the next event of the event that has the playback position on the scrubbing bar. To change the background color, check this item and specify the value for R, G, and B. The specified color is displayed on the right.

<p>[Selected Event Background Color]</p>	<p>Sets to show/hide the background color indicating the selected event. To change the background color, check this item and specify the value for R, G, and B. The specified color is displayed on the right.</p>
<p>[Show keyboard shortcuts(A-Z, Function, 0-9 Key only)]</p>	<p>Sets to show/hide the keyboard shortcut icon assigned to the event. * Icons can be shown only when the [A] to [Z] keys, function keys, and [0] to [9] keys on the keyboard are assigned.</p>
<p>[Show progress bar]</p>	<p>Sets to show/hide the progress bar of the playback.</p>

➤ **[Playlist Placeholder] dialog box (workstation mode only)**

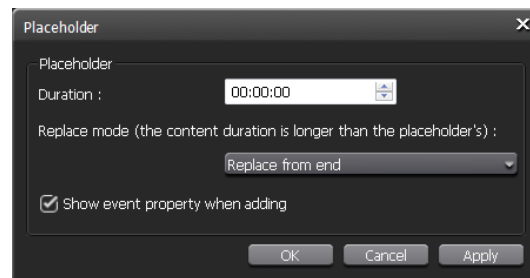

<p>[Duration:]</p>	<p>Sets the duration of the place holder (hour/minute/second).</p>
<p>[Replace mode (the content duration is longer than the placeholder's):]</p>	<p>Allows to select the replace mode from the list if the duration of the source is longer than that of the set place holder.</p> <p>[Replace] Replaces with a place holder maintaining the length of the source.</p> <p>[Replace from start] Replaces only the duration of the place holder from the In point.</p> <p>[Replace from end] Replaces only the duration of the place holder from the Out point.</p>
<p>[Show event property when adding]</p>	<p>By checking, displays the property screen of the place holder.</p>

➤ **[Preview update interval:] dialog box (workstation mode only)**

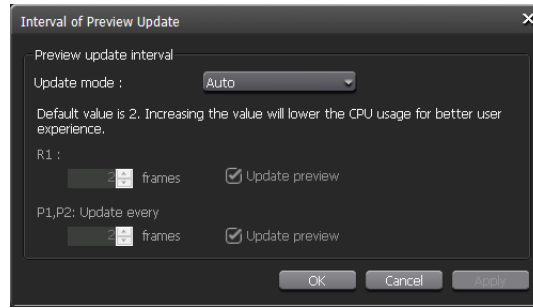

<p>[Update mode:]</p>	<p>To set the update interval of preview automatically, select [Auto], and to set it manually, select [Manual].</p>
<p>[R1:]/ [P1, P2, P3: Update every]*1</p>	<p>Set when [Manual] is selected in [Update mode]. Enter the number of frames in [frames] of [R1:] or [P1, P2 ,P3: Update every]. If the value is larger, the preview update interval becomes longer. (By default, the preview is updated every two frames.) If you do not want to update the preview, uncheck [Update preview].</p>

*1 Settings for P3 channel are only available on a model that can use P3 channel.

➤ **Date and time setting dialog box**

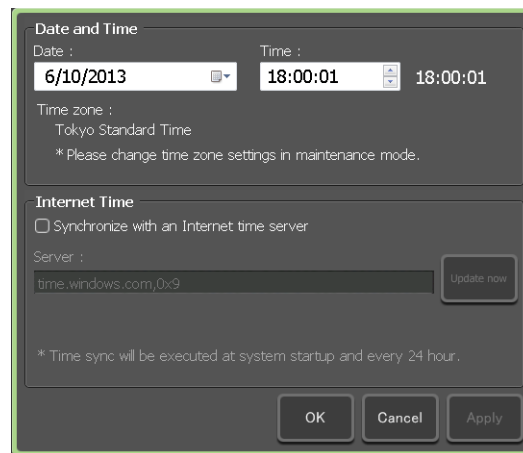

<p>[Date :]</p>	<p>By clicking the icon on the calendar, sets the date.</p>
<p>[Time :]</p>	<p>Sets the time.</p>

[Time zone :]	Displays the current time zone setting. This setting can be changed in the maintenance mode. For more information about the maintenance mode, refer to the T2 Service Manual.
[Internet Time]	Checking [Synchronize with an Internet time server], and then restarting or clicking [Update now] synchronizes with the Internet time server. Synchronization of time can be set from 1 to 24 hours. (Workstation mode only)

2 Set each item and tap [OK].

Tap [Apply] to keep on making settings of other items.

Recorder settings

Recorder – Input Settings

You can make settings for input format to record in the Recorder channel.

1 Tap [R1], and then tap the [Input Settings] tab in the setting screen.

➤ [Input Settings] tab

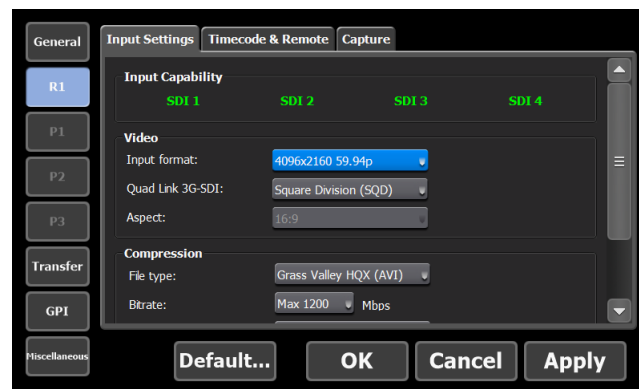

[Input Capability]	According to the selection for [IO Mode] in [General] -> the [Hardware] tab, displays the connector to be used for input with green highlight. [IO Mode Setting] dialog box▶P191
[Quad Link 3G-SDI:]*1	Selects the input format of Quad Link 3G-SDI between [Square Division (SQD)] and [2-Sample Interleave (2SI)]. This option is available only when the input format is “3840×2160 50/59.94p” or “4096×2160 50/59.94p”.

<p>[Video]</p>	<p>[Input format:] Selects the format for video input.</p> <p>[Aspect:] For SD input, selects the aspect ratio.</p>
<p>[Compression]</p>	<p>[File type :] Selects the compression format.</p> <p>[Bitrate :] Selects a bit rate that supports the compression format.</p> <p>[Audio format :] Selects an audio format that supports the compression format.</p> <p>[ClosedGOP] By check this item when a compatible codec is used, all the information will be included within the GOP. It increases the data size, but allows re-editing with editor software that can handle GOP. Uncheck it normally.</p>

*1 This setting is not available for T2 4K Express/T2 4K Express Plus.

TIP

- You can load a file being recorded to an external media/storage to editing software, and operate time-shift editing.
Loading and editing T2 contents to editing software ▶ P71
- Chasing playback during recording data is available.
Loading and playing back video currently recorded (chasing playback) ▶ P99

NOTE

- While recording in the MXF (XDCAM HD422/HD/IMX/DV, Apple ProRes 422 HQ/422/422 LT/422 Proxy, Avid DNxHD 220/145/100/36) format is being performed, some sources (such as clips with restricted playback counts) cannot be played back. If this is the case, playback will be stopped. While recording in the MXF (XDCAM HD422/HD/IMX/DV, Apple ProRes 422 HQ/422/422 LT/422 Proxy, Avid DNxHD 220/145/100/36) format is being performed, format conversion is not available.

2 Set each item and tap [OK].

Tap [Apply] to keep on making settings of other items.

Recorder – Timecode & Remote settings

You can make settings for the timecode or Recorder channel remote control when recording in the Recorder channel.

- 1 Tap [R1], and then tap the [Timecode & Remote] tab in the setting screen.

➤ [Timecode & Remote] tab

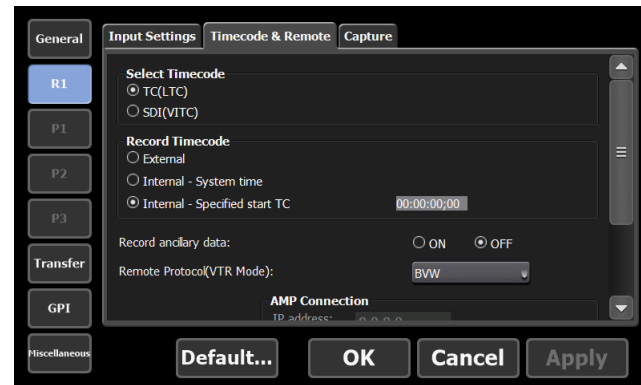

[Select Timecode]	Selects the timecode type from [TC(LTC)] and [SDI (VITC)].
[Recorded Timecode]	<p>Selects the timecode to use for recording. To use the timecode of an external device, select [External].</p> <p>To use the time of T2, select [Internal - System time].</p> <p>If [Internal - Specified start TC] is selected, tap the entry area and specify the timecode.</p>

<p>[Record ancillary data]</p>	<p>Sets whether to include VANC data while recording.</p> <p>If [ON] is selected, ancillary data is added on recorded video, which can be played back on T2.</p> <p>If video is recorded in the MXF format of XDCAM HD or HD422, store the ancillary data according to SMPTE 436M. In this case, the ancillary data can be exported to a device compatible with SMPTE 436M.</p> <p>Chase playback of the video with ancillary data is also available. Only one playback channel can be used while chase playback is being performed.</p> <p>Loading and playing back video currently recorded (chasing playback) ► P99</p>
<p>[Remote Protocol(VTR Mode):]</p>	<p>When controlling a VTR from T2 in the Recorder-VTR mode, selects remote protocol (AMP/BVW).</p> <p>If [AMP] is selected, set the IP address and channel of the VTR in [AMP Connection].</p>
<p>[Remote Protocol(Remote Mode):]</p>	<p>When controlling a T2 from an external controller in the Recorder-remote mode, selects a remote protocol (AMP/BVW).</p> <p>Check [Enable local operations while being remote controlled.] to operate T2 locally even in the remote mode.</p>

TIP

- If [Enable local operations while being remote controlled.] is checked, the operations available in the Recorder-remote mode are as follows.
 - Recording and stop
 - Entering a clip name
 - Editing tags (workstation mode only)
 - Displaying properties
 - Unloading clips
 - Setting markers, moving to markers

2 Set each item and tap [OK].

Tap [Apply] to keep on making settings of other items.

Recorder – Capture settings

You can set whether to automatically export files being recorded in the Recorder channel.

1 Tap [R1], and then tap the [Capture] tab in the setting screen.

➤ [Capture] tab

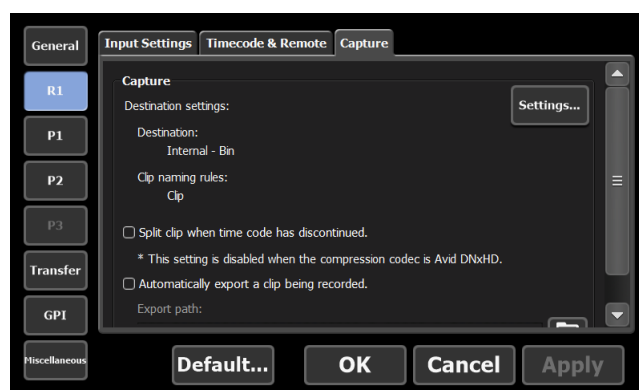

[Destination settings :]	Indicates the saving destination of the clips to be recorded and other information. Tapping [Settings...] allows to set the saving destination. Saving destination dialog box▶P212
[Split clip when time code has discontinued.]* ¹	By checking, divides clips when saving if the timecode being recorded is not continuous.
[Automatically export a clip being recorded.]	By checking, exports the file being recorded in the Recorder channel to the specified location automatically.
[Export path:]	By tapping, allows to specify the export destination.
[VTR Capture]* ²	Sets operations for the Recorder-VTR mode. [Preroll :] Sets the preliminary operation time (preroll) when recording is started. [Margin :] Sets the length of the margin added at In and Out points at recording operation.

<p>[VTR Batch Capture]*²</p>	<p>Sets the operations for batch capturing.</p> <p>[Clip:] Allows to change the clip name generated after the batch capture.</p> <p>[When an error occurs, continue to capture the following items.] By unchecking, recording of the next items and later to be batch captured will be stopped when an error occurs.</p> <p>[Completed items are not captured.] By unchecking, includes items whose batch capturing has completed as the target in the next capturing operation.</p>
--	---

*1 Disabled if the compression codec is Avid DNxHD.

*2 Only available in the workstation mode.

➤ **Saving destination dialog box**

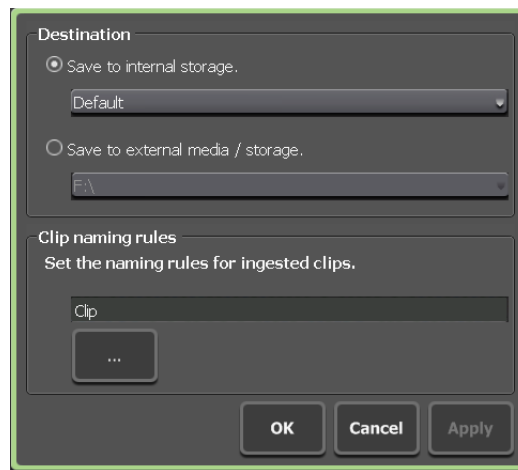

<p>[Destination]</p>	<p>Selects the saving destination of the clips to be recorded.</p> <p>To save the clips to T2, select [Save to internal storage.], and then select the bin that is registered to T2 from the list.</p> <p>Checking [Ingest to the selected bin] saves clips to the bin selected in the bin display area.</p> <p>To save the clips to a destination other than T2, select [Save to external media / storage.]*¹</p> <p>If <non-registered> is indicated, set the external storage in advance.</p> <p>Displaying media file in removable media ▶ P52</p>
-----------------------------	--

<p>[Clip naming rules]</p>	<p>Sets the naming rule of clips to be saved. Tapping the entry area allows to enter the clip name. Clicking [...] enters [Date] and/or [Time] after the clip name automatically. If the name of the clip to be recorded next has been set in the Recorder channel, the clip name setting for the next recorded clip is prioritized. Displaying Recorder channel in 1ch view ▶ P41</p>
-----------------------------------	---

*1 Only available in the workstation mode.

TIP

- If the data cannot be saved to an external storage at the time when recording starts, it is saved to the internal storage.
- If writing does not catch up, the recording will be stopped.

2 Set each item and tap [OK].

Tap [Apply] to keep on making settings of other items.

Player settings

Player – Video settings

You can make settings for output format to load video to the Player channel and play it.

1 Tap [P1] (or [P2]), and then tap the [Video] tab in the setting screen.

➤ [Video] tab

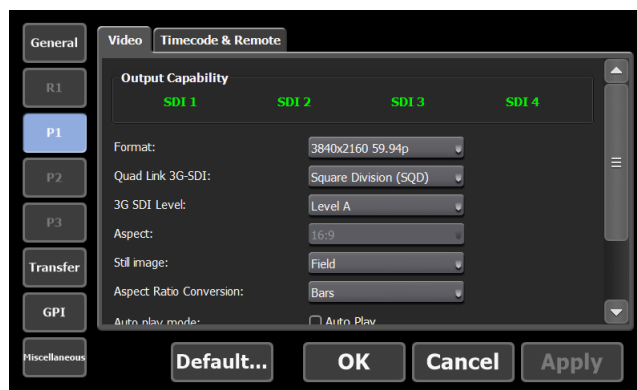

[Output capability]	According to the selection for [IO Mode] in [General] -> the [Hardware] tab, displays the connector available for output with green highlights. [IO Mode Setting] dialog box► P191
[Format:]	Selects the format for video output.
[Quad Link 3G-SDI:]*1	Selects the output format of Quad Link 3G-SDI between [Square Division (SQD)] and [2-Sample Interleave (2SI)]. This option is available only when the output format is “3840×2160 50/59.94p” or “4096×2160 50/59.94p”.
[3G SDI Level:]*1	Selects the signal for 3G SDI output between Level A and Level B.
[Aspect:]	For SD, selects the aspect ratio from [4:3] and [16:9].
[Still image:]	Selects the display mode when playback has paused. Selecting [Field] performs field corrections between still images. The video is displayed in a smooth still image. Selecting [Frame] displays the top field and bottom field alternately. The video is displayed to be shaking.

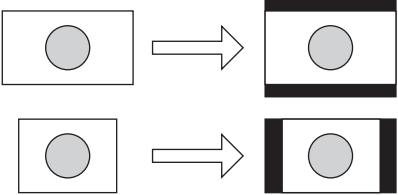
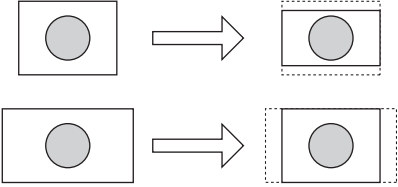
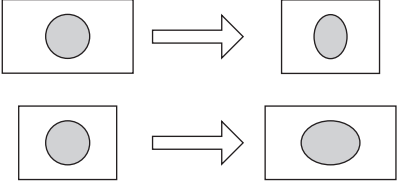
<p>[Aspect Ratio Conversion:]</p>	<p>Selects how conversion is to be performed when the aspect ratio of the source loaded to the Player channel differs from the channel settings.</p> <p>Selecting [Bars] displays black bars in the upper and lower or in the right and left.</p>  <p>Selecting [Crop] cuts the upper and lower parts or the right and left parts.</p>  <p>Selecting [Stretch] enlarges or reduces the whole image to fit the frame size of the screen.</p> 
<p>[Auto play mode:]</p>	<p>Checking [Auto Play] automatically plays the video when a source is loaded to the Player channel.</p>
<p>[Automatically mount a clip being recorded on the player, when it's ready for playback.]</p>	<p>By checking, automatically loads a source being recorded in the Recorder channel to the Player channel when the source become transmittable.</p>
<p>[When a subclip is created in R1, automatically mount it in the playlist of the player.]</p>	<p>By checking, automatically adds a sub clip created in the Recorder channel to a playlist loaded to the Player channel.</p>

*1 This setting is not available for T2 4K Express/T2 4K Express Plus.

NOTE

- Even when [Automatically mount a clip being recorded on the player, when it's ready for playback.] or [When a subclip is created in R1, automatically mount it in the playlist of the player.] was checked, they do not work in the following cases.
 - The specified channel is locked or the sync mode is set to on
 - The specified channel is in the Fill/Key signal output mode
 - The specified channel is in the remote mode (except when the local operations are enabled in the remote mode)
 - Being in the IO mode with no playback channel

2 Set each item and tap [OK].

Tap [Apply] to keep on making settings of other items.

Player – Timecode & Remote settings

You can make settings for the timecode & remote control of Player channel.

1 Tap [P1] (or [P2]), and then tap the [Timecode & Remote] tab in the setting screen.

➤ [Timecode & Remote] tab

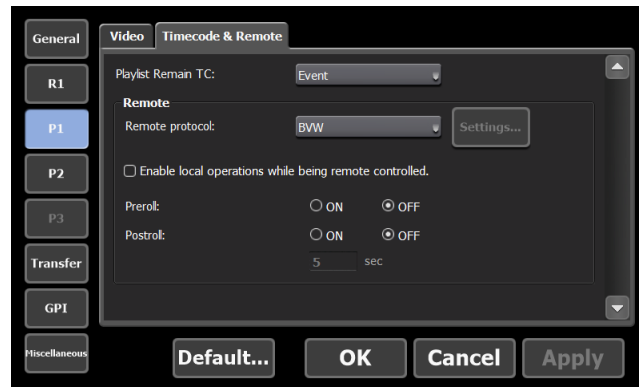

[Playlist Remain TC:]

Selects the display style for the remaining time of playlist for on-screen display.

Selecting [Event] displays the remaining time of the event.

Selecting [Total] displays the remaining time of the whole playlist.

<p>[Remote protocol:]</p>	<p>When controlling T2 from an external controller in the Player-remote mode, selects a remote protocol (AMP/BVW/TC Chase). Overview of AMP control ▶ P236 Overview of BVW control ▶ P237 Overview of TC Chase control ▶ P237</p> <p>[Settings...] Can be selected when TC Chase is selected for the remote protocol. TC Chase setting dialog box ▶ P218</p>
<p>[Enable local operations while being remote controlled.]</p>	<p>By checking, allows to operate T2 locally even in the remote mode.</p>
<p>[Preroll :]</p>	<p>Rewinds a short duration of time before the In point and starts playback from the point.</p>
<p>[Postroll :]</p>	<p>Allows to set the playback duration by the seconds in order to play back video later than the Out point.</p>

- TIP**
- If [Enable local operations while being remote controlled.] is checked, the operations available in Player-remote mode are as follows.
 - Scrubbing bar operations (workstation mode only)
 - Playback control operations (move to the first frame, rewind, frame reverse, stop, playback, frame forward, fast forward, and move to the last frame)
 - Moving to In/Out points, setting In/Out points, deleting In/Out points, creating sub clips
 - Switching display scale of the scrubbing bar
 - Switching audio level display
 - Creating thumbnail
 - Entering names of clips/playlists
 - Editing tags (workstation mode only)
 - Entering values for In point/Out point/duration, setting In point/Out point/duration
 - Editing playlist events list (add, delete, sort, copy, paste, and change names)
 - Displaying properties
 - Loading and unloading clips/playlists
 - Switching on/off for the sync mode, E to E mode, Loop mode
 - Operations with buttons on the lower part of the LCD
 - Setting markers, moving to markers

➤ **TC Chase setting dialog box**

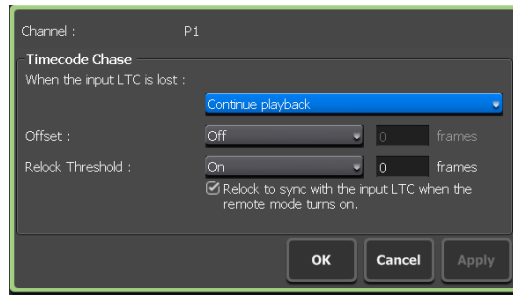

[Internet Time]

Configures settings regarding the TC Chase control.

[When the input LTC is lost :]

Sets the operation when the input LTC is lost. Select [Continue playback] to continue playback along the input timecode. Select [Stop playback] to stop playback.

[Offset :]

Sets the offset for the input LTC. Select [Off] not to be set for the offset and to play back with the same timecode as the input LTC. Select [On] to set the offset with a desired number of frames (-15 to 15 frames). This is locked with the offset value set for the input LTC.

[Relock Threshold :]

Sets the threshold of timecode difference between input LTC and Player channel where the relocking function is to be activated to perform chasing.

Selecting [Off] disables the relocking function.

By selecting [On], you can set a desired frame number (between -15 and +15) for the difference that activates the relocking function.

If [Relock to sync with the input LTC when the remote mode turns on.] is checked, the timecode of input LTC and Player channel will be relocked in the accurate frames regardless of the set relocking threshold value, when the remote mode is switched from off to on.

2 Set each item and tap [OK].

Tap [Apply] to keep on making settings of other items.

Transfer settings

Transfer – common settings

You can make settings for file transfer.

- 1 Tap [Transfer], and then tap the [Common] tab in the setting screen.

➤ [Common] tab

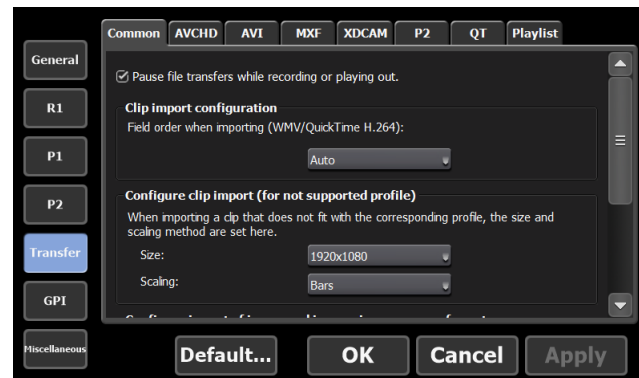

[Pause file transfers while recording or playing out.]

By unchecking, enables transfer and conversion even during a recording or playback. However, if this option is unchecked, the recording/playback operations may not be performed normally, therefore, we recommend that you use the system with this option checked.

[Clip import configuration]

Selects the field order when importing Windows Media Audio and H.264 (QuickTime Video (avc1)). Selecting [Auto] automatically selects and sets the appropriate field order.

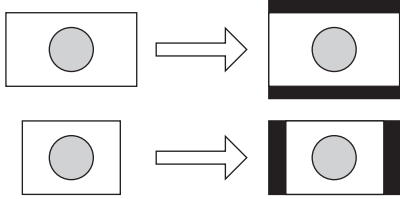
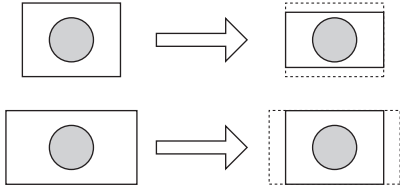
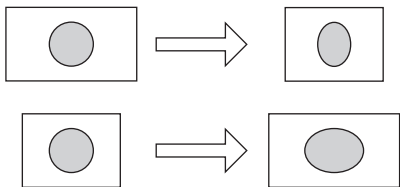
<p>[Configure clip import (for not supported profile)]</p>	<p>Sets the frame size and scaling method when importing media files that do not match the profile supported by T2.</p> <p>[Size:] Selects the frame size for import.</p> <p>[Scaling:] Selects the scaling method when the frame size of the imported source differs from that set in [Size:]. Selecting [Bars] displays black bars in the upper and lower or in the right and left, to fit the long sides of the frame of the source to that set in [Size:].</p>  <p>Selecting [Crop] cuts the upper and lower parts or the right and left parts, to fit the short sides of the frame of the source to that set in [Size:].</p>  <p>Selecting [Stretch] stretches or reduces the whole image, to fit the frame size of the source to that set in [Size:].</p> 
--	--

[Configure import of image and images in a sequence format]

Makes settings for import of still images or sequence still images.

[Format:]

Selects the format for import.

[Aspect:]

For SD, selects the aspect ratio from [4:3] and [16:9].

[Scaling:]

Selects the scaling method when the frame size of the imported source differs from that of the format set in [Format:].

Selecting [Bars] displays black bars in the upper and lower or in the right and left, to fit the long sides of the frame of the source to that of [Format:].

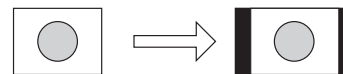
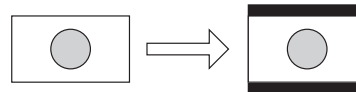

Selecting [Crop] cuts the upper and lower parts or the right and left parts, to fit the short sides of the frame of the source to that of [Format:].

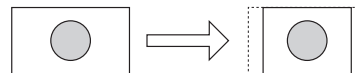
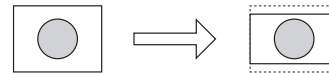

Selecting [Stretch] stretches or reduces the whole image, to fit the frame size of the source to that of [Format:].

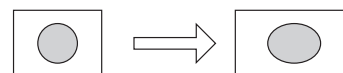

[Duration(still image):]

Sets the playback duration of the imported still images by seconds.

2 Set each item and tap [OK].

Tap [Apply] to keep on making settings of other items.

Transfer – AVCHD settings

You can make settings for the format to import AVCHD sources.

- 1 Tap [Transfer], and then tap the [AVCHD] tab in the setting screen.

➤ [AVCHD] tab

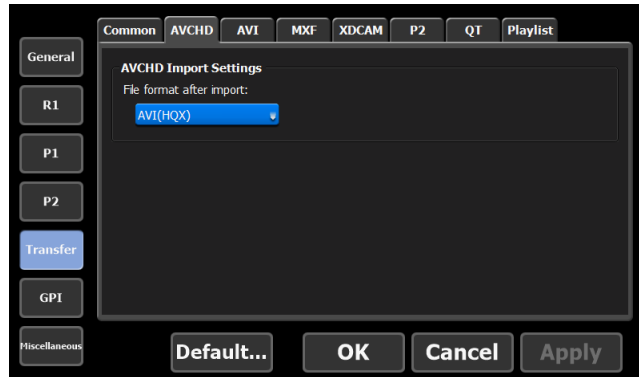

[AVCHD Import Settings]

[File format after import:]

Selects whether to import the file in the native format or in a converted format at the time of import.

Selecting [AVI (HQX)] converts the files to Grass Valley HQX AVI format.

- 2 Set each item and tap [OK].

Tap [Apply] to keep on making settings of other items.

Transfer – AVI settings

You can make settings for the format when converting contents in Grass Valley HQX AVI format to MXF or MOV format to export.

Format supported for conversion ► P259

1 Tap [Transfer], and then tap the [AVI] tab in the setting screen.

➤ [AVI] tab

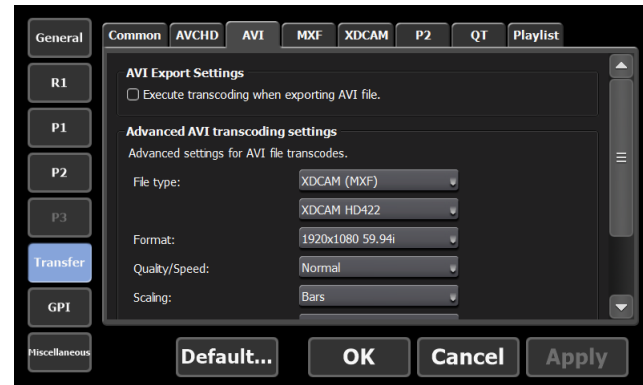

[AVI Export Settings]	<p>[Execute transcoding when exporting AVI file.] By checking, converts files to the format set in [Advanced AVI transcoding settings] to export.</p>
[Advanced AVI transcoding settings]	<p>Part of available setting items differ according to the codec selected for [File type:].</p> <p>[File type:] Selects the file type.</p> <p>[Format:] Selects the format.</p> <p>[Quality/Speed:] Selects the quality.</p>

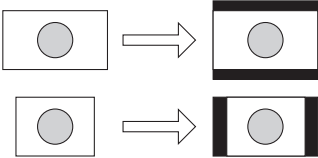
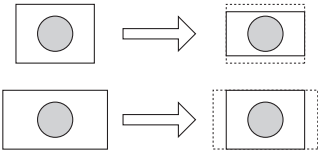
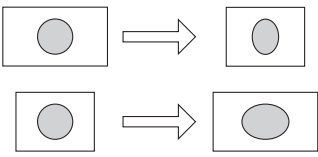
<p>[Advanced AVI transcoding settings]</p>	<p>[Scaling:] Selects the scaling method when the frame size of the exported contents differs from that of the format set in [Format:]. Selecting [Bars] displays black bars in the upper and lower or in the right and left, to fit the long sides of the frame of the contents to that of [Format:].</p>  <p>Selecting [Crop] cuts the upper and lower parts or the right and left parts, to fit the short sides of the frame of the contents to that of [Format:].</p>  <p>Selecting [Stretch] stretches or reduces the whole image, to fit the frame size of the contents to that of [Format:].</p>  <p>[Audio format:] Selects the audio format.</p> <p>[ClosedGOP] By checking, the information are closed within GOP. It increases the data size, but allows re-editing with editor software. Uncheck it normally.</p>
---	--

2 Set each item and tap [OK].

Tap [Apply] to keep on making settings of other items.

Transfer – MXF settings

You can make settings for the format to import MXF sources.

- 1 Tap [Transfer], and then tap the [MXF] tab in the setting screen.

➤ [MXF] tab

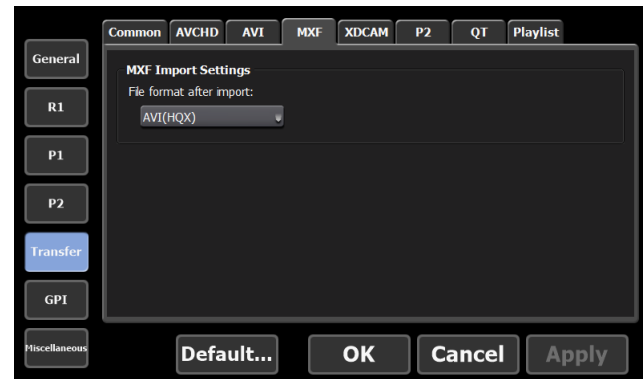

[MXF Import Settings]

[File format after import:]

Selects whether to import the file in the native format or in a converted format at the time of import.

Selecting [AVI (HQX)] converts the files to Grass Valley HQX AVI format.

- 2 Set each item and tap [OK].

Tap [Apply] to keep on making settings of other items.

Transfer – XDCAM settings

You can make settings for the format to import XAVC, XDCAM, and XDCAM EX sources.

1 Tap [Transfer], and then tap the [XDCAM] tab in the setting screen.

➤ [XDCAM] tab

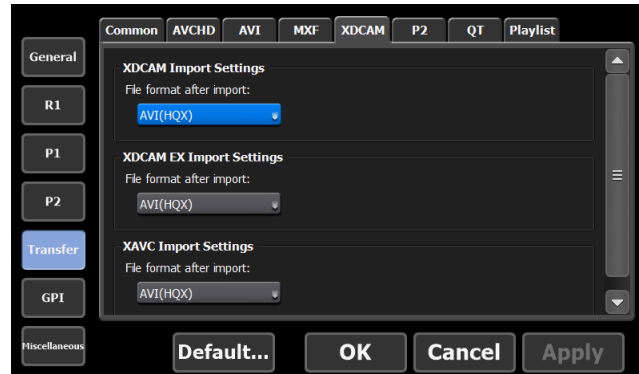

<p>[XDCAM Import Settings]</p>	<p>[File format after import:] Selects whether to import the file in the native format or in a converted format at the time of import. Selecting [AVI (HQX)] converts the files to Grass Valley HQX AVI format.</p>
<p>[XDCAM EX Import Settings]</p>	<p>[File format after import:] Selects whether to import the file in the native format or in a converted format at the time of import. Selecting [AVI (HQX)] converts the files to Grass Valley HQX AVI format.</p>
<p>[XAVC Import Settings]</p>	<p>[File format after import:] Selects whether to import the file in the native format or in a converted format at the time of import. Selecting [XAVC] imports the source in the native format. If the format of the file does not support the native format import, it is converted to Grass Valley HQX AVI automatically. Selecting [AVI (HQX)] converts the files to Grass Valley HQX AVI format.</p>

2 Set each item and tap [OK].

Tap [Apply] to keep on making settings of other items.

Transfer – P2 settings

You can make settings for the format to import P2 sources.

- 1 Tap [Transfer], and then tap the [P2] tab in the setting screen.

➤ [P2] tab

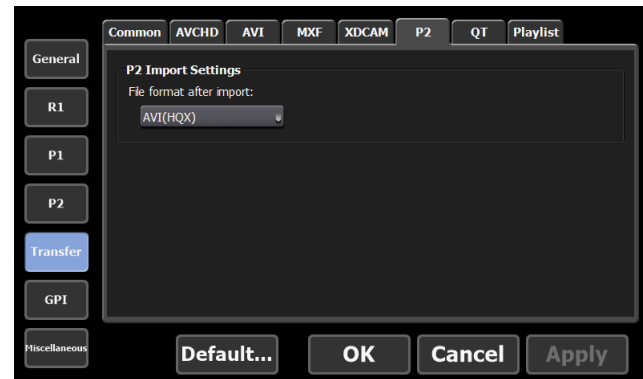

[P2 Import Settings]

[File format after import:]

Selects whether to import the file in the native format or in a converted format at the time of import.

Selecting [P2] imports the source in the native format. If the format of the file does not support the native format import, it is converted to Grass Valley HQX AVI automatically.

Selecting [MXF (OP-1a)] converts the files to MXF (OP-1a).

Selecting [AVI (HQX)] converts the files to Grass Valley HQX AVI format.

- 2 Set each item and tap [OK].

Tap [Apply] to keep on making settings of other items.

Transfer – QT settings

You can make settings for the format to import QuickTime sources.

- 1 Tap [Transfer], and then tap the [QT] tab in the setting screen.

➤ [QT] tab

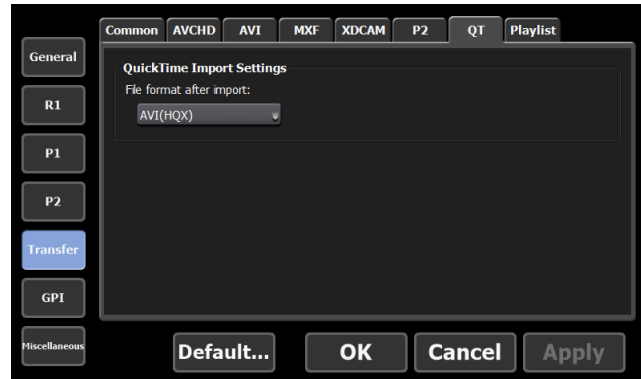

[QuickTime Import Settings]

[File format after import:]

Selects whether to import the file in the native format or in a converted format at the time of import.

Selecting [QuickTime] imports the source in the native format. If the format of the file does not support the native format import, it is converted to Grass Valley HQX AVI automatically.

Selecting [AVI (HQX)] converts the files to Grass Valley HQX AVI format.

- 2 Set each item and tap [OK].

Tap [Apply] to keep on making settings of other items.

Transfer – Playlist settings

You can make settings for the format to export playlists.

- 1 Tap [Transfer], and then tap the [Playlist] tab in the setting screen.

➤ [Playlist] tab

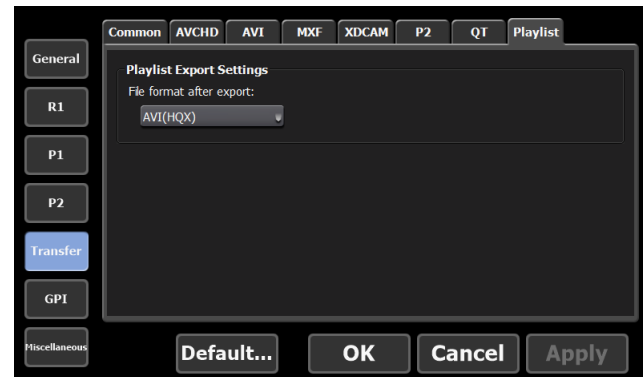

[Playlist Export Settings]

[File format after export:]

Selects the format for export.

Selecting [Use AVI transcode settings] converts the files with a codec selected for [Advanced AVI transcoding settings] in the [AVI] tab and exports it.

Selecting [AVI (HQX)] converts the files to Grass Valley HQX AVI and exports it.

- 2 Set each item and tap [OK].

Tap [Apply] to keep on making settings of other items.

GPI settings

GPI – Input settings

You can make settings to control T2 with GPI input.

1 Tap [GPI], and then tap the [Input] tab in the setting screen.

➤ [Input] tab

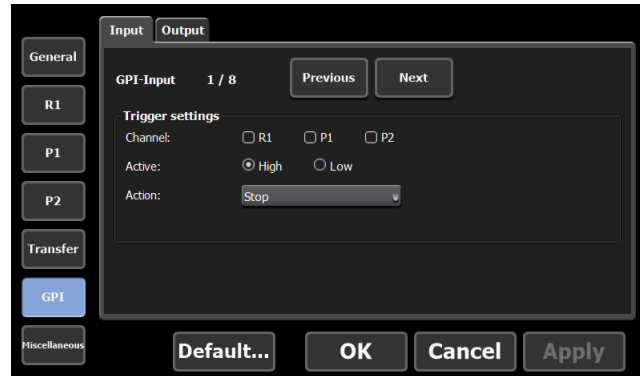

[GPI-Input]	Displays the number of the selected GPIO input pin. Tap [Previous] or [Next] and select a GPIO input pin to set.
[Trigger settings]	<p>Sets the GPI input trigger.</p> <p>[Channel:] Selects the channel to control with GPI input.</p> <p>[Active:] Selects the GPI signal to activate from [High] and [Low].</p> <p>[Action:] Selects the action when the GPIO input pin selected in [GPI-Input] is input.</p> <p>List of actions for trigger setting ► P230</p>

➤ List of actions for trigger setting

[Stop]	Stops playback or recording.
[Play]	Plays the contents loaded to the channel.
[Record]	Starts recording.
[Rewind]	Rewinds contents. When it comes to the beginning of the loaded contents or when performing another operation, rewinding stops.

[FastFwd]	Fast forwards contents. When it comes to the end of the loaded contents or when performing another operation, fast forwarding stops.
[CueStart]	Moves to the In point of the loaded contents.
[CueEnd]	Moves to the Out point of the loaded contents.
[Eject]	Unloads the loaded contents.
[Preview]	Loads the clip that is loaded to the R1 channel to the P1 channel.
[CueNextEvent]	When loading a playlist, moves to the next event of the selected event. It allows to include the position of the next marker as a moving destination. In the [Marker] dialog box, check [Show marker icons on the scrub bar], click [When moving to edit point :] list and select [Cue up on Markers]. [Marker] dialog box►P124
[CuePrevEvent]	When loading a playlist, moves to the previous event of the selected event. It allows to include the position of the previous marker as a moving destination. In the [Marker] dialog box, check [Show marker icons on the scrub bar], click [When moving to edit point :] list and select [Cue up on Markers]. [Marker] dialog box►P124
[VARPlayback]	Performs variable playback of the loaded contents in the speed specified in [VAR setting:]. Miscellaneous – Jog/Shuttle settings►P233
[VARPlay+0.1]	Increase playback speed by x0.1.
[VARPlay-0.1]	Decrease playback speed by -x0.1.
[VARPlay+0.01]	Increase playback speed by x0.01.
[VARPlay-0.01]	Decrease playback speed by -x0.01.
[Keyboard Shortcut]	Assign GPI Input 1 - 8 to a key on the keyboard. When GPI input is active, the keyboard shortcuts will be active. Major keyboard shortcuts►P172

2 Set each item and tap [OK].

Tap [Apply] to keep on making settings of other items.

GPI – Output settings

You can make settings to control external devices by T2 with GPI output.

1 Tap [GPI], and then tap the [Output] tab in the setting screen.

➤ [Output] tab

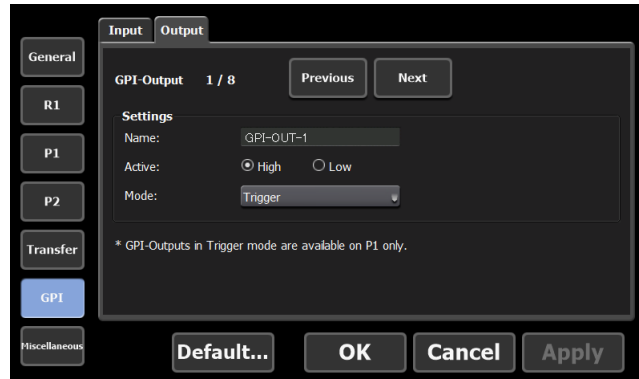

[GPI-Output]	Displays the number of the selected GPIO output pin. Tap [Previous] or [Next] and select a GPIO output pin to set.
[Settings]	Sets the GPI output trigger. [Name:] Sets the name of the GPI output trigger. [Active:] Selects the GPI signal to activate from [High] and [Low]. [Mode:] Sets the GPI output trigger mode. Selecting [Trigger] controls an external device with GPI output by specifying a trigger for an event in the playlist loaded to the P1 channel of T2. Selecting [Tally - R1] outputs tally signal from GPI and lights up the tally lamp of the external monitor while recording in the R1 channel. Selecting [Tally - P1] (or [Tally - P2] or Tally - P3* ¹) outputs tally signal from the GPI and makes the tally lamp on the external monitor lit while playback (including single or variable speed, fast-forward, and rewind) is performed on the P1 channel (or P2 or P3 channel).

*1 Settings for P3 channel are only available on a model that can use P3 channel.

2 Set each item and tap [OK].

Tap [Apply] to keep on making settings of other items.

Other settings

Miscellaneous – Jog/Shuttle settings

You can make settings for operations of the jog/shuttle.

- 1 Tap [Miscellaneous], and then tap the [Jog/Shuttle] tab in the setting screen.

➤ [Jog/Shuttle] tab



[Shuttle speed:]	Selects the maximum speed for playback when playing with the jog/shuttle.
[VAR setting:]	Selects the playback speed when [VARPlayback] is selected in [Trigger settings] in the [GPI] -> [Input] tab of the setting screen.

- 2 Set each item and tap [OK].

Tap [Apply] to keep on making settings of other items.

Miscellaneous – AMP settings

You can make settings for the AMP command actions when you control T2 from an external device with the AMP command.

- 1 Tap [Miscellaneous], and then tap the [AMP] tab in the setting screen.

➤ [AMP] tab

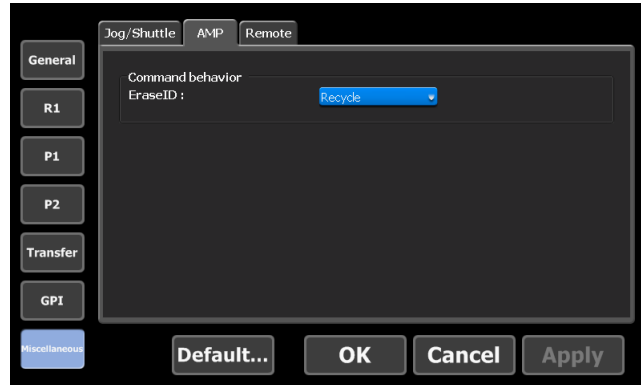

[Command behavior]

[EraseID:]

Makes settings for the actions of Erase ID command of AMP.

Selecting [Recycle] moves the contents to the recycle bin.

Selecting [Delete] deletes the contents completely.

- 2 Set each item and tap [OK].

Tap [Apply] to keep on making settings of other items.

Miscellaneous – Remote settings

You can make settings for the remote actions when you control T2 from an external device with the GPI/RS422 command.

- 1 Tap [Miscellaneous], and then tap the [Remote] tab in the setting screen.

➤ [Remote] tab

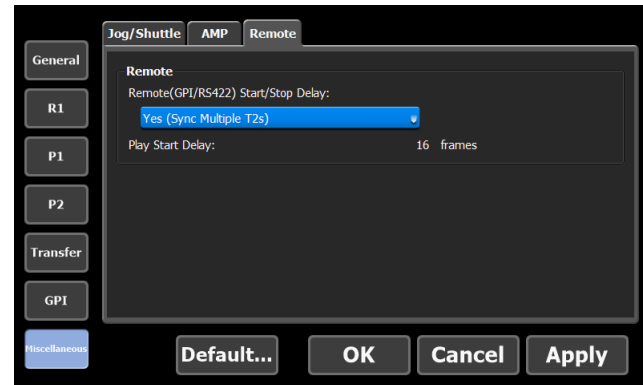

[Remote(GPI/RS422) Start/Stop Delay:]

Sets delay to be applied when the playback start or stop command is executed while GPI control is performed.

Selecting [No (Minimum)] doesn't set delay. Select this option when it is not necessary to synchronize multiple T2s.

Selecting [Yes (Sync Multiple T2s)] sets delay. When multiple T2s are used, this is selected.

Selecting [Custom] sets delay. You can set custom delay frames.

- 2 Set each item and tap [OK].

Tap [Apply] to keep on making settings of other items.

Remote Control

This section describes the remote control using GPI input/output, AMP command, BVW, and TC Chase command.

Remote control using AMP/BVW/TC Chase

Overview of AMP control

For T2, the following AMP control are available via Ethernet.

Controlling an external device from T2 with AMP/BVW (Recorder-VTR mode) ▶ P238

Controlling T2 from an external controller with AMP/BVW (Recorder-remote mode) ▶ P238

Controlling T2 from an external controller with AMP/BVW (Player-remote mode) ▶ P239

TIP

- For the AMP commands list, see “Appendix”.
AMP command list ▶ P265
- For AMP specifications and settings, refer to the Grass Valley AMP protocol documents on our website or the following URL.
http://www.gvgdevelopers.com/concrete/apis/amp_protocol/documentation/
- For sample source codes of AMP protocol, refer to our website or the following URL.
http://www.gvgdevelopers.com/concrete/apis/amp_protocol/amp-socket-connection-example/
- The port number of T2 for connecting AMP is 3811.
- The strings for channel names are as follows: “vtr1” for R1, “vtr2” for P1, “vtr3” for P2, and “vtr4” for P3.

NOTE

- The AMP commands for T2 do not support controlling via RS422.
- AMP control sample program software is not eligible for product support.

Overview of BVW control

For T2, the following BVW control are available via RS422.

Controlling an external device from T2 with AMP/BVW (Recorder-VTR mode) ▶ P238

Controlling T2 from an external controller with AMP/BVW (Recorder-remote mode) ▶ P238

Controlling T2 from an external controller with AMP/BVW (Player-remote mode) ▶ P239

TIP

- For the BVW list of commands used in the Recorder-VTR mode, see “Appendix”.
BVW command list ▶ P278
- For the availability of BVW commands used in the remote mode, see “Appendix”.
BVW list supporting remote mode ▶ P279
- For the input/output pin assignment of RS422, see “Appendix”.
RS422 input/output pin ▶ P280
- For synchronized mode or Fill/Key signal output mode, BVW commands can only control the P1 channel.
Sync playback of contents (Sync mode) ▶ P101
Playback of contents with alpha channel (Fill/Key signal output mode) ▶ P103

Overview of TC Chase control

T2 supports playback of Player channel whose frame accuracy synchronizes with SMPTE-compliant LTC.

Controlling T2 with TC Chase (Player-remote mode) ▶ P240

TIP

- For synchronized mode or Fill/Key signal output mode, TC Chase commands can only control the P1 channel.
Sync playback of contents (Sync mode) ▶ P101
Playback of contents with alpha channel (Fill/Key signal output mode) ▶ P103

Controlling an external device from T2 with AMP/BVW (Recorder-VTR mode)

The operation of T2 to control an external device (VTR) with the AMP command (via Ethernet) or BVW command (via RS422), using T2 as a controller (master) is described in this part.

When you use the BVW command, you do not need to perform steps 1 to 3.

- 1 Tap [Config.] on the touch screen LCD of T2.
- 2 Tap [General], and then tap the [Network-1] tab or [Network-2] tab.
- 3 Set the IP address of T2.

General – Network-1/Network-2 settings ► P194

- 4 Tap [R1], and then tap [Timecode & Remote].
- 5 Select a remote protocol from the list of [Remote Protocol(VTR Mode):].

If [BVW] is selected, proceed to step 7.

- 6 If [AMP] is selected in step 5, set the IP address and channel of the VTR.
- 7 Tap [OK].
- 8 Press the [R1] button, and then tap [VTR].

Controlling of an external device from T2 with AMP command or BVW command will be enabled.

Controlling T2 from an external controller with AMP/BVW (Recorder-remote mode)

The settings of T2 to control the Recorder channel of T2 from an external controller with the AMP command (via Ethernet) or BVW command (via RS422) is described in this part.

T2 accepts commands from the external controller as a device (slave).

- 1 Tap [Config.] on the touch screen LCD of T2.
- 2 Tap [R1], and then tap the [Timecode & Remote] tab.
- 3 Select a remote protocol from the list of [Remote Protocol(Remote Mode):].

TIP • Check [Enable local operations while being remote controlled.] to operate T2 locally even in the remote mode.
Recorder – Timecode & Remote settings► P209

4 Tap [OK].

5 Press the [R1] button, and then tap [Remote].

Controlling of Recorder channel from an external controller with AMP or BVW command will be enabled.

Controlling T2 from an external controller with AMP/BVW (Player-remote mode)

The settings of T2 to control the Player channel of T2 from an external controller with the AMP command (via Ethernet) or BVW command (via RS422) is described in this part.

T2 accepts commands from the external controller as a device (slave).

1 Tap [Config.] on the touch screen LCD of T2.

2 Tap [P1] or [P2], and then tap the [Remote] tab.

Player – Timecode & Remote settings► P216

3 Select a remote protocol from the list of [Remote protocol:].

TIP • Check [Enable local operations while being remote controlled.] to operate T2 locally even in the remote mode.
Player – Timecode & Remote settings► P216

4 Tap [OK].

5 Press the [P1] button.

6 Tap [Menu], and then tap [Remote].

[Remote] will be checked.

Controlling of Player channel from an external controller with AMP or BVW command will be enabled.

TIP • For Erase ID command of AMP, you can set whether or not to delete clips completely.
Miscellaneous – AMP settings► P234

Controlling T2 with TC Chase (Player-remote mode)

This section describes the settings for TC Chase control to perform playback where the LTC input and the timecode of Player channel are synchronized.

TC Chase control requires reference signal input, in addition to the LTC input.

1 Tap [Config.] on the touch screen LCD of T2.

2 Tap [General], and then tap the [Hardware] tab.

General – Hardware settings►P189

3 Select a [External] from the list of [Reference :].

Confirm that it is synchronized with the input reference signal correctly.

4 Tap [P1] or [P2], and then tap the [Video] tab.

Player – Video settings►P213

5 Select the format to playback.

6 Tap the [Remote] tab of [P1] or [P2].

Player – Timecode & Remote settings►P216

7 Select a [TC Chase] from the list of [Remote protocol:].

TIP • Check [Enable local operations while being remote controlled.] to operate T2 locally even in the remote mode.
Player – Timecode & Remote settings►P216

8 Tap [OK].

9 Press the [P1] or [P2] button.

10 Tap [Menu], and then tap [Remote].

[Remote] will be checked.

Player channel will be played back, being synchronized with the input LTC.

TIP • In the workstation mode, you can check the timecode and timecode chase status of input LTC and Player channel.
Timecode Status display►P148

Remote control using GPI

Overview of GPI control

For T2, the following GPI control are available.

➤ Controlling T2 with GPI input

You can control T2 by assigning actions to the GPIO input port (8 pins). GPI input will be accepted regardless whether T2 is in the remote mode or the channel is locked.

On T2, configure the settings in [GPI] -> [Input] tab of the setting screen.

GPI – Input settings▶P230

NOTE • When controlling T2 with GPI input, do not use RS422 at the same time. Controlling with RS422 may become disabled.

➤ Controlling external devices from T2 with GPI output

Controlling external devices from T2 with GPI output▶P241

➤ Tally output from GPI

You can configure your T2 to output tally signal from GPI and turn on the tally lamp of an external monitor while playing back or recording video.

On T2, configure the settings in [GPI] -> [Output] tab of the setting screen.

GPI – Output settings▶P232

TIP • For GPI input/output pin, see “Appendix”.
GPI settings▶P230

Controlling external devices from T2 with GPI output

You can control an external device with GPI output by specifying a trigger for an event in the playlist loaded to the P1 channel of T2.

1 Tap [Config.] on the touch screen LCD of T2.

2 Tap [GPI], and then tap [Output].

GPI – Output settings▶P232

3 Tap [Previous] or [Next] and select a GPIO output pin.

The number of the selected pin is displayed on the right of [GPI-Output].

4 Set [Name:] and [Active:] in the trigger setting, and select [Trigger] from the list of [Mode].

5 Tap [OK].

- 6 Load the playlist including the event to specify a trigger to the P1 channel.
- 7 Press the [P1] button.
- 8 Tap an event to set the trigger from the event list to select it.
The selected event is displayed with a blue frame.
- 9 Tap [Menu], and then tap [Event Properties].
- 10 Tap the [GPI] tab.
- 11 Check [Trigger GPI] and select the name of the trigger setting set in step 4 from the list.
- 12 Select an action of the event to be the trigger.

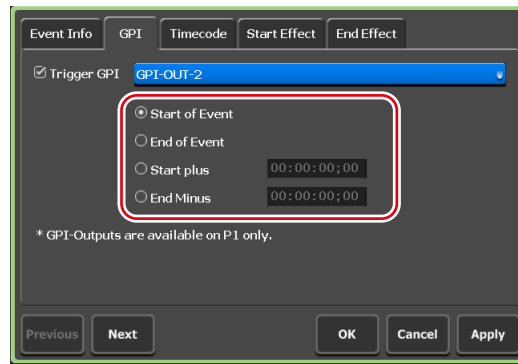

- Select [Start of Event] to set the playback start of an event to be the trigger.
 - Select [End of Event] to set the playback end of an event to be the trigger.
 - Select [Start plus] to add a specified time to the time of playback start of an event and set it to be the trigger. Tap the timecode and enter the time to add.
 - Select [End Minus] to subtract a specified time from the time of playback end of an event and set it to be the trigger. Tap the timecode and enter the time to subtract.
- 13 Tap [OK].

Utilizing ASIO audio device

This section describes how to use ASIO audio devices.

Using USB audio interface

Overview

The following data can be output from T2 via the output terminal of the USB audio interface.

- Audio being played back on the Player channel (Ch1 - Ch8)
- Audio currently in input preview on the Recorder channel (Ch1 - Ch8)

TIP

- T2 software needs to be updated to Version 3.2.1 or later.

Checking the model name and software version ▶ P40

- The USB audio interface compatible with ASIO needs to satisfy the following conditions.
 - Compatibility with ASIO 2.0 (Output in 48 kHz sampling rate format is supported. Also, it is recommended that at least 24 bit in the bit depth is supported.)
 - The USB audio interface and driver software are compatible with Windows 10 (1607 Anniversary Update).

Operation-ensured products and versions for network audio (ASIO audio) ▶ P256

NOTE

- Even when all the conditions above are satisfied, performance is not guaranteed on all USB audio interface.

Step 1: Installing the driver software on T2

Follow the instruction manual supplied by the manufacturer of your USB audio interface, and install the driver software on T2.

The following procedure shows an example for a general USB audio interface.

1 Connect a keyboard, mouse, and display to T2.

2 Connect the USB audio interface to the USB terminal of T2.

Rear panel ▶ P30

3 Start up T2 in the maintenance mode.

TIP • For details on the maintenance mode, see the T2 service manual.

4 Install the driver software provided by the manufacturer of your USB audio interface.

5 Configure the audio interface settings (as necessary).

6 Start up T2 in the CommandCenter mode.

TIP • For details on the CommandCenter mode, see the T2 service manual.

Step 2: Configuring the ASIO audio device on T2

Make settings for audio output on the T2 side.

1 Start up T2 and switch to the workstation mode.

Starting up T2►P35

Switching from the front panel mode to the workstation mode►P37

2 Click [Settings], and click [General] -> [Hardware].

General – Hardware settings►P189

3 Click [Settings...] of [ASIO audio device:].

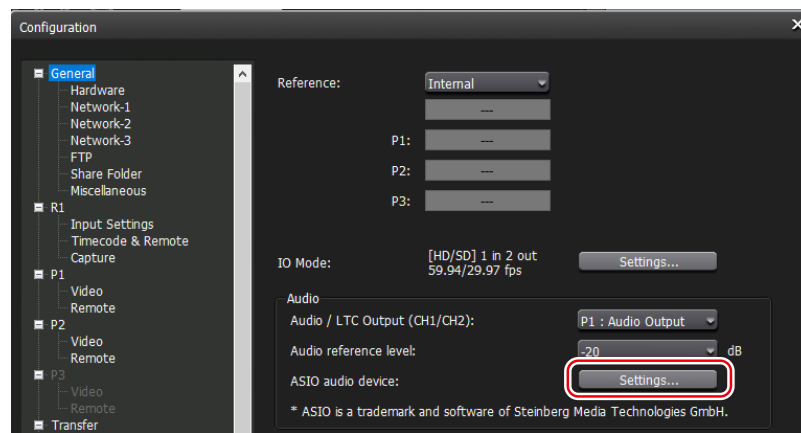

- 4** In the [ASIO audio device] dialog box, select an ASIO audio device to use from the list of [Device:].

In the list of [Device:], the audio channels are listed according to the specifications of the ASIO audio device.

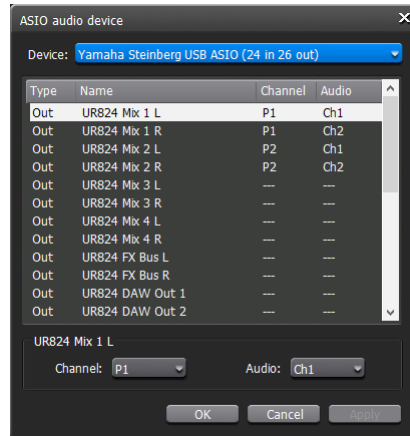

- 5** For each audio output channel displayed in the audio terminal list, set the Player channel to be assigned in [Channel:], and set the audio channel to be assigned in [Audio:] (Ch1 - Ch8).
- 6** Click [OK].

Using network audio (Dante Virtual Soundcard)

Overview

By installing Dante Virtual Soundcard (software) on T2, digital audio output can be performed via network.

Dante network audio feature enables the following output from T2.

- Audio being played back on the Player channel (Ch1 - Ch8) can be output to the Dante network
- Audio currently in input preview on the Recorder channel (Ch1 - Ch8) can be output to the Dante network
- (By combining with a device that supports Dante) Audio signal can be output from T2 while being played back via the Dante network, using a Dante compatible device in a remote location

TIP

- For details on Dante, Dante Virtual Soundcard, and Dante Controller, see the following URL of Audinate.
<https://www.audinate.com/>
- For technical documentation on Dante, see the following URL.
<https://www.audinate.com/resources/technical-documentation>

Step 1: Installing Dante Virtual Soundcard software

1 Obtain Dante Virtual Soundcard software and a license (charged).

TIP • Dante Virtual Soundcard software and license are available from the following URL.
<https://www.audinate.com/products/software/dante-virtual-soundcard>

2 Connect a keyboard, mouse, and display to T2.

3 Start up T2 in the maintenance mode.

TIP • For details on the maintenance mode, see the T2 service manual.

4 On T2 in the maintenance mode, install Dante Virtual Soundcard software, and then activate the license.

Step 2: Configuring Dante Virtual Soundcard on T2

1 On T2 in the maintenance mode, go to the start menu, and click [Audinate] -> [Dante Virtual Soundcard].

The setting application of Dante Virtual Soundcard will start up.

2 In the [Settings] tab, select [ASIO] for [Audio Interface:].

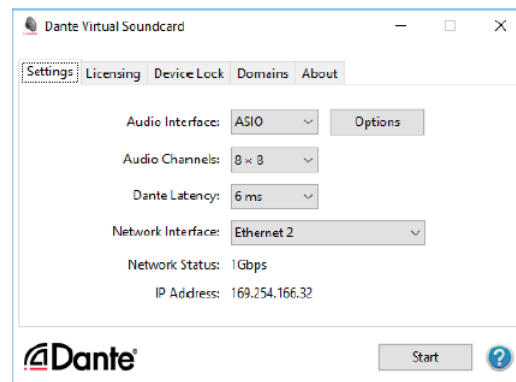

3 For [Audio Channels:], set the maximum number of audio channels to be output from T2 to the Dante network.

“The number of input audio channels × The number of output audio channels” is indicated in the field.

In the example of the following screen, a total of eight channels of audio will be output to the Dante network.

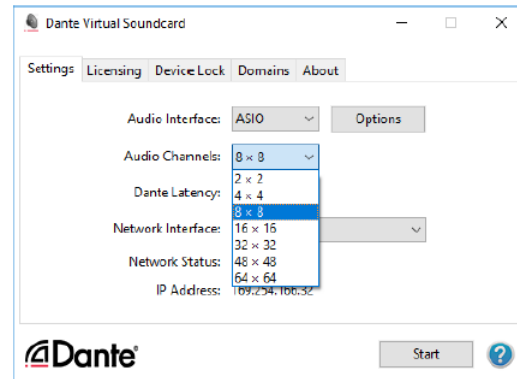

NOTE • T2 does not use input audio channels from the Dante network.

4 For [Network Interface:], select the network port for the Dante network.

[Ethernet] corresponds to the left LAN terminal on the T2 rear panel, and [Ethernet 2] corresponds to the right LAN terminal.

Rear panel ► P30

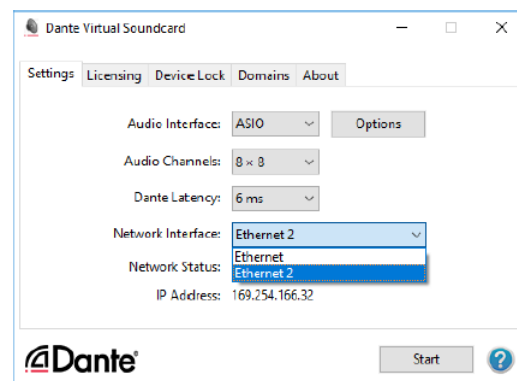

5 Click [Start].

Dante Virtual Soundcard service will be started.

On T2, Dante Virtual Soundcard service is recognized as ASIO audio device.

6 Start up T2 in the CommandCenter mode.

TIP • For details on the CommandCenter mode, see the T2 service manual.

Step 3: Configuring the ASIO audio device on T2

Make audio output settings on T2.

- 1 Start up T2 and switch to the workstation mode.

Starting up T2►P35

Switching from the front panel mode to the workstation mode►P37

- 2 Click [Settings], and click [General] -> [Hardware].

General – Hardware settings►P189

- 3 Click [Settings...] of [ASIO audio device:].

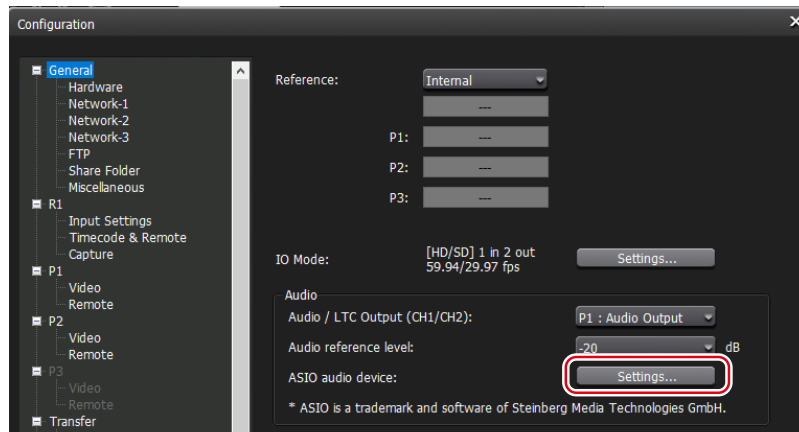

- 4 In the [ASIO audio device] dialog box, select the Dante Virtual Soundcard from the list of [Device:].

In the list of [Device:], the audio channels are listed according to the specifications of the Dante Virtual Soundcard service.

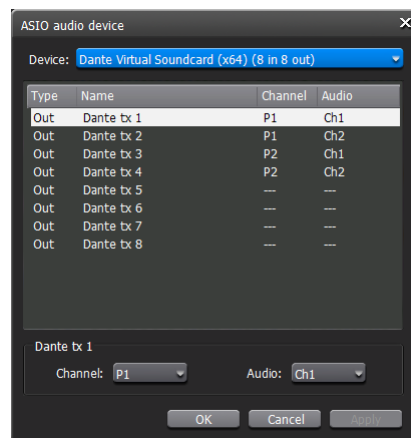

5 For each audio output channel displayed in the audio terminal list, set the Player channel to be assigned in [Channel:], and set the audio channel to be assigned in [Audio:] (Ch1 - Ch8).

6 Click [OK].

Step 4: Connecting T2 to the Dante network

1 Connect T2 to the Dante network.

Connect either one of the LAN terminals on the rear panel of T2 to the Dante network.

Rear panel ► P30

TIP • The IP address of T2 can be set by tapping [Settings] on T2, and then selecting [General] -> [Network 1] or [Network 2]. [Network 1] corresponds to the LAN terminal on the left, and [Network 2] corresponds to the LAN terminal on the right.
General – Network-1/Network-2 settings ► P194

2 Use the Dante Controller of the PC on the Dante network to map audio output.

The following screen shows an example in which output of top two channels of the 16 output channels set on T2 are mapped to the L/R audio output terminal of Focusrite RedNet AM2, using the Dante controller.

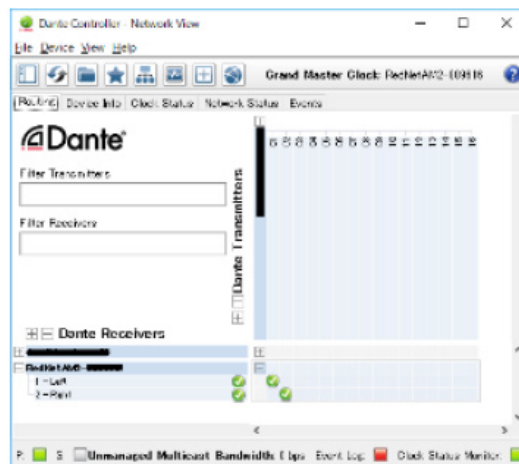

Once the setting has been mapped, it will be applied automatically even when the T2 main unit is restarted.

TIP • For details on Dante Controller, see the following URL.
<https://www.audinate.com/products/software/dante-controller>

Appendix

This section includes the list of the keyboard shortcut in the workstation mode, input/output format, operation-ensured drivers for each device, AMP command, and BVW command.

Keyboard shortcut list in workstation mode

The following list shows the keyboard shortcuts.

TIP • In the workstation mode, you can change keyboard shortcut assignments.
Changing keyboard shortcut assignment ► P172

Category	Action	Shortcut
[General]	[Select R1 channel]	[1]
	[Select P1 channel]	[2]
	[Select P2 channel]	[3]
	[Select P3 channel]*7	[4]
	[Change focus to the folder list]	
	[Change focus to the content list]	
	[Change focus to the playlist of the selected channel]	
	[Change focus to the marker list of the selected channel]	
	[Switch between 1ch View and 2ch/3ch View]	
	[Change the content's tab]	
	[Show the Configuration screen]	
	[Show the content search screen]	
	[Lock/Unlock the selected channel]	
	[Turn On/Off the Loop in the selected channel (P1/P2/P3)]*7	
	[Turn On/Off the EtoE in the selected channel (P1/P2)]	
	[Turn On/Off the Remote of the selected channel (P1/P2/P3)]*7	
	[Turn the sync play mode On/Off]	
	[Show / Hide the expand setting in the selected channel]	
	[Show the audio setting in the selected channel]	
	[Show the VAR setting in the selected channel]	
	[Show the timecode status in the selected channel]	
	[Show the marker list in the selected channel]	

Category	Action	Shortcut
[General]	[Eject the selected channel]	
	[Start Recording the selected channel (R1)]	[M]
	[Start playback in the selected channel]	[L]
	[Play reverse in the selected channel]	[J]
	[Play or pause the selected channel]	[Space]
	[Stop playing/recording in the selected channel]	[K]
	[Fast Forward (skip) in the selected channel]	[I]
	[Rewind (1 step back) in the selected channel]	[H]
	[Increase (1 step forward) the VAR speed in the selected channel]	[.]
	[Slower (1 step back) the VAR speed in the selected channel]	[,]
	[Increase (0.1 forward) the VAR speed in the selected channel]	
	[Slower (0.1 back) the VAR speed in the selected channel]	
	[Increase (0.01 forward) the VAR speed in the selected channel]	
	[Slower (0.01 back) the VAR speed in the selected channel]	
	[Move to top frame(previous event) of the selected channel]	[A]
	[Move to last frame(next event) of the selected channel]	[S]
	[Move to In point of the selected channel]	[Shift+I]
	[Move to Out point of the selected channel]	[Shift+O]
	[Move to the previous frame in the selected channel]	[<-]
	[Move to the next frame in the selected channel]	[->]
	[Move to the previous frame in the selected channel(JOG Mode)] ^{*1}	
	[Move to the next frame in the selected channel(JOG Mode)] ^{*1}	
	[Set the In point of the selected channel]	[I]
	[Set the Out point of the selected channel]	[O]
	[Clear the In/Out points of the selected channel]	[Ctrl]+[I] [Ctrl]+[O]
	[Fast forward (0.01 forward) the current speed in the selected channel]	
	[Fast forward (0.1 forward) the current speed in the selected channel]	
	[Slow (0.01 back) the current speed in the selected channel]	

Category	Action	Shortcut
[General]	[Slow (0.1 back) the current speed in the selected channel]	
	[Add the marker to the selected channel] ^{*2}	[V] ^{*3}
	[Add the marker to R1] ^{*2}	
	[Add the marker to P1] ^{*2}	
	[Add the marker to P2] ^{*2}	
	[Add the marker to P3] ^{*2*7}	
	[Load the content(s) to the selected channel] ^{*4}	
	[Load the content(s) to P1] ^{*4}	
	[Load the content(s) to P2] ^{*4}	
	[Load the content(s) to P3] ^{*4*7}	
	[Cue up to the event within the playlist in the selected channel] ^{*5}	
	[Cue up to the event within the playlist in the selected channel and pause] ^{*5}	
	[Cue up to the event within the playlist in the selected channel and play] ^{*5}	
	[Cue up to the event within the playlist P1] ^{*5}	
	[Cue up to the event within the playlist in P1 and pause] ^{*5}	
	[Cue up to the event within the playlist in P1 and play] ^{*5}	
	[Cue up to the event within the playlist P2] ^{*5}	
	[Cue up to the event within the playlist in P2 and pause] ^{*5}	
	[Cue up to the event within the playlist in P2 and play] ^{*5}	
	[Cue up to the event within the playlist P3] ^{*5*7}	
	[Cue up to the event within the playlist in P3 and pause] ^{*5*7}	
	[Cue up to the event within the playlist in P3 and play] ^{*5*7}	
	[Cue up to the marker in the selected channel] ^{*6}	
	[Cue up to the marker in the selected channel and pause] ^{*6}	
	[Cue up to the marker in the selected channel and play] ^{*6}	
	[Cue up to the marker in P1] ^{*6}	
	[Cue up to the marker in P1 and pause] ^{*6}	
	[Cue up to the marker in P1 and play] ^{*6}	
	[Cue up to the marker in P2] ^{*6}	
	[Cue up to the marker in P2 and pause] ^{*6}	
	[Cue up to the marker in P2 and play] ^{*6}	

Category	Action	Shortcut
[General]	[Cue up to the marker in P3] ^{*6*7}	
	[Cue up to the marker in P3 and pause] ^{*6*7}	
	[Cue up to the marker in P3 and play] ^{*6*7}	
[Contents List]	[Mount the selected item on the selected channel]	[Return]
	[Mount the selected item on the selected channel (with shifting the focus)]	
	[Mount the selected item on the selected channel and pause]	
	[Mount the selected item on the selected channel and pause (with shifting the focus)]	
	[Mount the selected item on the selected channel and play]	
	[Mount the selected item on the selected channel and play (with shifting the focus)]	
	[Mount the selected item on P1]	
	[Mount the selected item on P1 (with shifting the focus)]	
	[Mount and pause the selected item on P1]	
	[Mount and pause the selected item on P1 (with shifting the focus)]	
	[Mount and play the selected item on P1]	
	[Mount and play the selected item on P1 (with shifting the focus)]	
	[Mount the selected item on P2]	
	[Mount the selected item on P2 (with shifting the focus)]	
	[Mount and pause the selected item on P2]	
	[Mount and pause the selected item on P2 (with shifting the focus)]	
	[Mount and play the selected item on P2]	
	[Mount and play the selected item on P2 (with shifting the focus)]	
	[Mount the selected item on P3] ^{*7}	
	[Mount the selected item on P3 (with shifting the focus)] ^{*7}	
[Mount and pause the selected item on P3] ^{*7}		
[Mount and pause the selected item on P3 (with shifting the focus)] ^{*7}		
[Mount and play the selected item on P3] ^{*7}		

Category	Action	Shortcut
[Contents List]	[Mount and play the selected item on P3 (with shifting the focus)] ⁷	
	[Scroll to top of selected item]	[Home]
	[Scroll to last selected item]	[End]
	[Delete selected item]	[Delete]
	[Copy selected item]	[Ctrl]+[C]
	[Cut selected item]	[Ctrl]+[X]
	[Paste item from the clipboard]	[Ctrl]+[V]
	[Show the rename dialog box for the selected item]	
	[Change the thumbnail frame color of the selected item to the default color]	
	[Change the thumbnail frame color of the selected item to the color 1]	
	[Change the thumbnail frame color of the selected item to the color 2]	
	[Change the thumbnail frame color of the selected item to the color 3]	
	[Change the thumbnail frame color of the selected item to the color 4]	
	[Change the thumbnail frame color of the selected item to the color 5]	
	[Show the film strip for the selected item]	
	[Show the properties for the selected item]	
	[Playlist]	[Cue up to the selected event]
[Cue up and pause to the selected event]		
[Cue up and play to the selected event]		
[Delete the selected event]		[Delete]
[Copy the selected event]		[Ctrl]+[C]
[Paste the selected event]		[Ctrl]+[V]
[Show the rename dialog box of the selected event]		
[Set the fade in of the selected event to “none”]		
[Set the fade in of the selected event to “from black”]		
[Set the fade in of the selected event to “from white”]		
[Set the fade out of the selected event to “none”]		
[Set the fade out of the selected event to “from black”]		
[Set the fade out of the selected event to “from white”]		

Category	Action	Shortcut
[Playlist]	[Set the end effect action to “none” in the selected event]	
	[Set the end effect action to “Pause (Show black frame)” in the selected event]	
	[Set the end effect action to “Pause (Show white frame)” in the selected event]	
	[Set the end effect action to “Pause (Show last frame)” in the selected event]	
	[Set the end effect action to “Pause (Show next event frame)” in the selected event]	
	[Set the end effect action to “Pause (Show EtoE)” in the selected event]	
	[Set the end effect action to “loop” in the selected event]	
	[Show the properties of selected event]	
[Marker List]	[Cue up to the selected marker]	[Return]
	[Cue up and pause to the selected marker]	
	[Cue up and play to the selected marker]	
	[Delete the selected marker]	[Delete]
	[Show the edit dialog box of the selected marker]	
	[Add comment to the selected marker(s)] ^{*2}	

*1 Using the shortcut for controlling from an external controller JOG, you can move frames smoothly when consecutive commands are received. It is most suitable when assigned to the JOG of Shuttle Pro, etc.

*2 Can be assigned to marker comments (1 to 9).

*3 A marker without comment is added.

*4 Can mount clips and playlists that start with 00_ to 99_.

*5 Can be set to the maximum of 100 events.

*6 Can be set to the maximum of 100 markers.

*7 Settings for P3 channel are only available on a model that can use P3 channel.

Operation-ensured drivers for each device

Operation-ensured driver versions for XDCAM/XDCAM EX/XAVC/XAVC S

The operations of the following version of driver have been ensured on this product.

Product name	Version
XDCAM Drive Software	Ver. 5.0.9

Operation-ensured driver version for P2

The operations of the following version of driver have been ensured on this product.

Product name	Version
Memory Card Drive “P2 drive” AJ-PCD20	P2 Driver Ver. 2.29

Operation-ensured products and versions for USB audio interface (ASIO audio)

The operation of the following products and versions have been ensured on this product.

Product name	Version
steinberg UR824	TOOLS for UR824 V2.1.6
TASCAM US-16x08	Settings Panel V3.00

NOTE • Performance is not guaranteed for all operation.

Operation-ensured products and versions for network audio (ASIO audio)

The operation of the following products and versions have been ensured on this product.

Product name	Version
Audinate Dante Virtual Soundcard	v4.0.4.4

NOTE • Performance is not guaranteed for all operation.

Supported Formats

Supported formats of captured file (4K DCI/4K UHD)

Container	Codec
AVI	Grass Valley HQX
MXF	Grass Valley HQX

Supported formats of captured file (HD/SD)

Container	Codec
AVI	Grass Valley HQX
MXF	Grass Valley HQX, XDCAM HD422, XDCAM HD, IMX, DVCAM, Apple ProRes 422 HQ, Apple ProRes 422, Apple ProRes 422 LT, Apple ProRes 422 Proxy, Avid DNxHD 220, Avid DNxHD 145, Avid DNxHD 100, Avid DNxHD 36

Supported formats of imported file (4K DCI/4K UHD)

Container	Codec
AVI	Grass Valley HQX, Grass Valley Lossless ^{*1} , Grass Valley Uncompressed ^{*1}
MXF	H.264/AVC ^{*1} , Grass Valley HQX, Apple ProRes (422 HQ/422/422 LT/422 Proxy), Apple ProRes 4444 ^{*1}
QuickTime	Apple ProRes (422 HQ/422/422 LT/422 Proxy), Apple ProRes 4444 ^{*1} , Grass Valley HQX
MP4	H.264/AVC
XAVC	4K Intra (480 ^{*1} /300 ^{*1}), QFHD Intra (480 ^{*1} /300 ^{*1}), QFHD Long422 (200 ^{*1} /140 ^{*1} /100 ^{*1}), QFHD Long (150/100/60)
XAVC S	H.264/AVC
P2	AVC-Intra 4K (422 ^{*1})
Windows Media	Windows Media Video ^{*1}
Still Image	Targa ^{*1} , Windows Bitmap ^{*1} , JPEG ^{*1} , TIFF ^{*1} , PNG ^{*1} , GIF ^{*1} , DPX ^{*1} , YUV Bitmap ^{*1}

^{*1} Transcode to AVI (Grass Valley HQX) when importing.

Supported formats of imported file (HD/SD)

Container	Codec
AVI	Grass Valley HQX, Grass Valley HQ, Grass Valley Lossless* ¹ , Grass Valley Uncompressed* ¹ , DVCPRO HD, DVCPRO50, DVCPRO25, DV
MXF	MPEG-2, H.264/AVC, Avid DNxHD (220x/220/145/100/36), Grass Valley HQX, Grass Valley HQ, DVCPRO HD, DVCPRO50, DVCPRO25, DV, D10/IMX, JPEG2000, Apple ProRes (422 HQ/422/422 LT/422 Proxy)
QuickTime	Apple ProRes (422 HQ/422/422 LT/422 Proxy), Apple ProRes 4444* ¹ , XDCAM (HD422/HD), XDCAM EX, H.264* ¹ , MPEG-4* ¹ , Grass Valley HQX, Grass Valley HQ, DVCPRO HD* ¹ , DVCPRO50* ¹ , DVCPRO25* ¹ , DV* ¹ , Motion JPEG* ¹ , Uncompressed* ¹
MP4	H.264/AVC
XDCAM	XDCAM HD422, XDCAM HD, XDCAM IMX, XDCAM DV, XDCAM EX
XAVC	HD Intra (200/100/50), HD Long422 (50/35/25)
XAVC S	H.264/AVC
P2	AVC-LongG (50/25/12), AVC-Intra (200/100/50), DVCPRO HD, DVCPRO50, DVCPRO, DV
AVCHD	H.264/AVC
MPEG-2	PS* ¹ , TS* ¹
Windows Media	Windows Media Video* ¹
GXF	Grass Valley HQ* ² , MPEG-2 (Intra Frame)* ² , H.264/AVC (Intra Frame)* ² , DVCPRO HD* ² , DVCPRO50* ² , DVCPRO* ² , DV* ²
Still Image	Targa* ¹ , Windows Bitmap* ¹ , JPEG* ¹ , TIFF* ¹ , PNG* ¹ , GIF* ¹ , DPX* ¹ , YUV Bitmap* ¹

*1 Transcode to AVI (Grass Valley HQX) when importing.

*2 Rewrap to MXF when importing.

NOTE • Some codecs are able to output in one channel only.

Format supported for conversion

Format before conversion	Format after conversion	
	Container	Codec
Grass Valley HQX AVI or Playlist	MXF	Grass Valley HQX, XDCAM HD 422, XDCAM HD, XDCAM IMX, XDCAM DV, Apple ProRes 422 HQ, Apple ProRes 422, Apple ProRes 422 LT, Apple ProRes 422 Proxy, Avid DNxHD 220x, Avid DNxHD 220, Avid DNxHD 145, Avid DNxHD 100, Avid DNxHD 36
	MOV	Apple ProRes 422 HQ, Apple ProRes 422, Apple ProRes 422 LT, Apple ProRes 422 Proxy
Other format supported by T2	AVI	Grass Valley HQX

Video input and video output formats

T2 4K Elite/T2 4K Elite Plus/T2 4K Pro/T2 4K Pro Plus

Resolution	Video Input Format	Video Output Format
4K	4096 x 2160p (59.94p, 50p, 29.97p, 25p, 24p, 23.98p)	4096 x 2160p (59.94p, 50p, 29.97p, 25p, 24p, 23.98p)
UHD	3840 x 2160p (59.94p, 50p, 29.97p, 25p, 24p, 23.98p)	3840 x 2160p (59.94p, 50p, 29.97p, 25p, 24p, 23.98p)
HD	1920 x 1080p (59.94p, 50p, 29.97p, 25p, 24p, 23.98p), 1920 x 1080i (59.94i, 50i), 1920 x 1080PsF (24PsF, 23.98PsF) 1440 x 1080p (29.97p, 25p, 24p, 23.98p), 1440 x 1080i (59.94i, 50i), 1440 x 1080PsF (24PsF, 23.98PsF) 1280 x 720p (59.94p, 50p)	1920 x 1080p (59.94p, 50p, 29.97p, 25p, 24p, 23.98p), 1920 x 1080i (59.94i, 50i), 1920 x 1080PsF (24PsF, 23.98PsF) 1280 x 720p (59.94p, 50p)
SD	720 x 486i (59.94i), 720 x 576i (50i)	720 x 486i (59.94i), 720 x 576i (50i)

T2 4K Express/T2 4K Express Plus

Resolution	Video Input Format	Video Output Format
4K	4096 x 2160p (29.97p, 25p, 24p, 23.98p)	4096 x 2160p (29.97p, 25p, 24p, 23.98p)
UHD	3840 x 2160p (29.97p, 25p, 24p, 23.98p)	3840 x 2160p (29.97p, 25p, 24p, 23.98p)
HD	1920 x 1080p (29.97p, 25p, 24p, 23.98p), 1920 x 1080i (59.94i, 50i), 1920 x 1080PsF (24PsF, 23.98PsF) 1440 x 1080p (29.97p, 25p, 24p, 23.98p), 1440 x 1080i (59.94i, 50i), 1440 x 1080PsF (24PsF, 23.98PsF) 1280 x 720p (59.94p, 50p)	1920 x 1080p (29.97p, 25p, 24p, 23.98p), 1920 x 1080i (59.94i, 50i), 1920 x 1080PsF (24PsF, 23.98PsF) 1280 x 720p (59.94p, 50p)
SD	720 x 486i (59.94i), 720 x 576i (50i)	720 x 486i (59.94i), 720 x 576i (50i)

Notes on export and growing clip editing

○: Supported, ×: Not supported

Clip media type	State	Export		FTP export	
		Export	Growing clip editing on EDIUS	FTP export	Growing clip editing on EDIUS
Grass Valley HQX AVI	Recording	○	○ ^{*3}	× ^{*2}	—
	Finished recording	○	○ ^{*3}	○	×
Grass Valley HQX AVI to MXF ^{*1}	Recording	○	○ ^{*3}	○	×
	Finished recording	○	○ ^{*3}	○	○ ^{*4,5}
Grass Valley HQX AVI to MOV ^{*6}	Recording	○	×	○	×
	Finished recording	○	×	○	×
Grass Valley HQX MXF	Recording	○	○ ^{*3}	○	○ ^{*4,5}
	Finished recording	○	○ ^{*3}	○	○ ^{*4,5}
XDCAM	Recording	○	○ ^{*3}	○	○ ^{*4,5}
	Finished recording	○	×	○	○ ^{*4,5}

- *1 Transcode to MXF when exporting
- *2 Export starts after finishing record
- *3 Import to EDIUS bin to edit
- *4 Must be on K2 server to edit
- *5 Import to EDIUS Source Browser to edit
- *6 Transcode to MOV when exporting

Notes on record of external device and growing clip editing

○: Supported

Clip media type	State	Record of external device	
		Record	Growing clip editing on EDIUS
Grass Valley HQX AVI	Recording	○	○*1
Grass Valley HQX MXF	Recording	○	○*1
XDCAM	Recording	○	○*1
Apple ProRes MXF	Recording	○	○*1
Avid DNxHD MXF	Recording	○	○*1

*1 Import to EDIUS bin to edit

Notes on FTP download and growing clip editing

○: Supported, ×: Not supported

Clip media type	State	Record of external device	
		Record	Growing clip editing on EDIUS
Grass Valley HQX AVI	Recording	×*1	—
	Finished recording	○	×
Grass Valley HQX MXF	Recording	○	○*2
	Finished recording	○	○*2
XDCAM	Recording	○	○*2
	Finished recording	○	○*2
Apple ProRes MXF	Recording	○	○*2
	Finished recording	○	○*2
Avid DNxHD MXF	Recording	○	○*2
	Finished recording	○	○*2

*1 Not show the list of FTP client while recording

*2 Import to EDIUS Source Browser to edit

Notes on Direct Access Folder and growing clip editing (T2 4K Elite/T2 4K Elite Plus only)

○: Supported

Clip media type	State	Growing clip editing on EDIUS
Grass Valley HQX AVI	Recording	○*1
	Finished recording	○*1
Grass Valley HQX MXF	Recording	○*1
	Finished recording	○*1
XDCAM	Recording	○*1
	Finished recording	○*1
Apple ProRes MXF	Recording	○*1
	Finished recording	○*1
Avid DNxHD MXF	Recording	○*1
	Finished recording	○*1

*1 Import to EDIUS Bin Window to edit

NOTE • Time-shift editing is supported by EDIUS Workgroup 8 and EDIUS Workgroup 9. It is not available on EDIUS Pro/Neo series and EDIUS Express.

IO mode list

The following list shows the IO modes you can use on T2 4K Series. The available IO modes differ depending on the T2 model type.

TIP • When the IO mode is switched, the assignment to the terminals on the video I/O board and remote interface board are also switched.

Switching IO mode ► P38

Video I/O board (Elite/Pro/Express) ► P32

Video I/O board (Elite Plus/Pro Plus/Express Plus) ► P32

Remote interface board ► P33

NOTE • In each IO mode, the number of input or output may be restricted for some format types.

IO mode list - T2 4K Series (Elite/Pro/Express)

○: Supported, ×: Not supported

IO mode	Description	Availability by model		
		Elite	Pro	Express
[4K] 1 in 0 out	This mode inputs 4K format video to the Recorder channel R1 (1ch).	R1 (Quad SDI 1/2/3/4)		
[4K] 0 in 1 out	This mode outputs 4K format video to the Player channel P1 (1ch).	P1 (Quad SDI 1/2/3/4)		
[HD/SD] 1 in 2 out	This mode inputs HD or SD format video to the Recorder channel R1 (1ch), and outputs it to the Player channels P1/P2 (2ch). Sync mode and Fill/Key signal output mode can be enabled when the combination of P1/P2 channels is used.	R1 (SDI 1) P1 (SDI 3) P2 (SDI 4) Video monitor output (SDI 2)		
[HD/SD] 0 in 3 out	This mode outputs HD or SD format video to the Player channels P1/P2/P3 (3ch). Sync mode and Fill/Key signal output mode can be enabled when the combination of P1/P2 channels is used.	P1 (SDI 2) P2 (SDI 3) P3 (SDI 4) Video monitor output (SDI 1)		×

IO mode list - T2 4K Series (Elite Plus/Pro Plus/Express Plus)

○: Supported, ×: Not supported

IO mode	Description	Availability by model		
		Elite Plus	Pro Plus	Express Plus
[4K] 1 in 0 out	This mode inputs 4K format video to the Recorder channel R1 (1ch).	R1 (Quad SDI 1/2/3/4) Video monitor output (Quad SDI 5/6/7/8)		
[4K] 0 in 1 out	This mode outputs 4K format video to the Player channel P1 (1ch).	P1 (Quad SDI 5/6/7/8) Video monitor output (Quad SDI 1/2/3/4)		
[HD/SD] 1 in 2 out	This mode inputs HD or SD format video to the Recorder channel R1 (1ch), and outputs it to the Player channels P1/P2 (2ch). Sync mode and Fill/Key signal output mode can be enabled when the combination of P1/P2 channels is used.	R1 (SDI 1) P1 (SDI 5) P2 (SDI 6) Video monitor output (SDI 2, SDI 3, SDI 4)		
[HD/SD] 0 in 3 out	This mode outputs HD or SD format video to the Player channels P1/P2/P3 (3ch). Sync mode and Fill/Key signal output mode can be enabled when the combination of P1/P2 channels is used.	P1 (SDI 5) P2 (SDI 6) P3 (SDI 7) Video monitor output (SDI 1, SDI 2, SDI 3)	×	

AMP command list

The AMP commands available in T2 are listed in the following tables. The commands with gray-colored cells in the list are not supported by T2.

NOTE • The latency in the number of frames from the time the command such as Play or Stop is issued to the time the operation actually starts is not fixed. The video loaded on multiple T2 cannot be synchronized in the accurate frames by AMP commands.

Device management

Command		Channel-less mode	Recorder	Player	Sync mode	Fill/Key signal output mode	Supplementary note on T2 operation
01.06	Set Drop Frame Mode	○	○	○	○	○	[DF mode:] setting that is in [Miscellaneous] of [General] in the setting screen will be changed. Since [DF mode:] is a common setting for R1/P1/P2, the setting change will be applied to the other channels.
00.0C	Local Disable	No	○	○	○	○	Enabling and disabling of local control or remote control can be set for each channel.
0X.1D	Local Enable	No	○	○	○	○	Enabling and disabling of local control or remote control can be set for each channel.
00.11	Device Type Request	○	○	○	○	○	0x20 and 0x50 are returned corresponding to the device category and the model number, respectively.
20.04	Standby Off	No	No	No	No	No	
20.05	Standby On	No	No	No	No	No	
20.60	EE Off	No	No	○	No	No	
20.61	EE On	No	No	○	No	No	
21.62	Set Mute Mode	No	No	○	○	○	It takes several seconds from the time the command has been issued until the time the setting is applied.

Command		Channel-less mode	Recorder	Player	Sync mode	Fill/Key signal output mode	Supplementary note on T2 operation
A8.20	Set Device ID	○	○	○	○	○	
A0.21	Device ID Request	○	○	○	○	○	
A0.2C	Device Name Request	○	○	○	○	○	

Transport controls

Command		Channel-less mode	Recorder	Player	Sync mode	Fill/Key signal output mode	Supplementary note on T2 operation
2X.00	Stop	No	○	○	○	○	Specifying the timecode value on the command execution (event schedule) is not supported.
2X.01	Play	No	No	○	○	○	Specifying the timecode value on the command execution (event schedule) is not supported.
2X.02	Record	No	○	No	No	No	Specifying the timecode value on the command execution (event schedule) is supported only when the input type is LTC or VITC (SDI).
20.0F	Eject	No	○	○	○	○	
20.10	Fast Forward	No	No	○	No	No	Plays back the video in 32 times the normal play speed.
2X.11	Jog Forward	No	No	○	No	No ^{*1}	
2X.12	Variable Forward	No	No	○	No	No ^{*1}	
2X.13	Shuttle Forward	No	No	○	No	No ^{*1}	

Command		Channel-less mode	Recorder	Player	Sync mode	Fill/Key signal output mode	Supplementary note on T2 operation
20.20	Rewind	No	No	○	No	No	Plays back in reverse the video in 32 times the normal play speed.
2X.21	Jog Reverse	No	No	○	No	No* ¹	
2X.22	Variable Reverse	No	No	○	No	No* ¹	
2X.23	Shuttle Reverse	No	No	○	No	No* ¹	
2X.31	Cue Up With Data	No	No	○	○	○	A pseudo clip "<BLACK>" is not supported.
20.52	Tension Release	No	No	No	No	No	
44.05	User Bits Preset	No	No	No	No	No	Not supported on T2.
40.20	In Reset	No	No	○	○	○	
41.36	Timecode Mode Preset	No	○	No	No	No	For the Recorder channel, the setting will be applied on the timecode that is saved when video is recorded. For LTC, the timecode of TC input is recorded, and for VITC, the timecode of SDI input is recorded.
40.40	Auto Mode Off	No	No	○	○	○	
40.41	Auto Mode On	No	No	○	○	○	
41.42	Set Loop Playback Mode	No	No	○	○	○	If you want to change the setting during the playback, send the command approximately four or more seconds before it comes to the position to set loop.

Command		Channel-less mode	Recorder	Player	Sync mode	Fill/Key signal output mode	Supplementary note on T2 operation
41.43	Set Widescreen Mode	No	○	No	No	No	
41.44	Set Stop Mode	No	No	○	○	○	If you want to change the setting during the playback, send the command approximately four or more seconds before it comes to the position to set stop.
40.45	Get Stop Mode	No	No	○	○	○	
60.0B	State Change Latency Request	No	No	No	No	No	Not supported on T2.
61.0C	Current Time Sense	○	○	○	○	○	Since obtaining User Bits is not supported, 00000000 will always be returned. The response is always the same value regardless of the type of LTC or VITC. If LTC source or VITC source has been specified, Recorder input timecode is returned. Only 1:LTC, 4:Timer, 8:WindowsTime, and 40:LTC (Src) (Recorder LTC input) are supported.
61.20	Status Sense*2	○	○	○	○	○	
AX.02	Record Cue Up With Data	No	○	No	No	No	Only specifying the clip name is available.

*1 Operates only when the specified speed is 0 (Stop).

*2 Supported status flag

Data0	Busy, Remote+Local/ Local
Data1	Play, Record, FFW, REW, Stop

Data2	Still, TapeDirection, Var, Shuttle
Data3	InPreset, OutPreset, AutoMode, FolderalreadyExist, InvalidFolderName, FolderDeletionFail, SourceMissing
Data4	EEOn, LoopPlayBack
Data9	FolderNotFound, OutPresetFail, PreviewInPreset, PreviewOutPreset
DataA	IDNotFound, MovieDeleteComplete, MovieDeleteFail
DataD	TapeTop, TapeEnd, LTC, Timer, VITC, TimeOfDay, DropFrame

Managing clips on the timeline

Command		Channel-less mode	Recorder	Player	Sync mode	Fill/Key signal output mode	Supplementary note on T2 operation
4X.14	In Preset	No	No	○	○	○	A pseudo clip "<BLACK>" is not supported.
4X.15	Out Preset	No	No	○	○	○	If you want to set an Out point during the playback, send the command approximately four or more seconds before it comes to the position to set the Out point.
4F.16	Append Preset	No	No	○	○	○	If you want to execute the command during the playback, send the command approximately four or more seconds before it comes to the end point of Preset Timeline.
4X.21	Out Reset	No	No	○	○	○	If you want to set an Out point during the playback, send the command approximately four or more seconds before it comes to the position to set the Out point.
A0.06	Preview In Reset	No	No	○	○	○	

Command		Channel-less mode	Recorder	Player	Sync mode	Fill/Key signal output mode	Supplementary note on T2 operation
AX.07	Preview Out Reset	No	No	○	○	○	If you want to set an Out point during the playback, send the command approximately four or more seconds before it comes to the position to set the Out point.
44.31	Pre-roll	No	No	No	No	No	Not supported on T2.
AX.04	Preview In Preset	No	No	○	○	○	If you want to execute the command during the playback, send the command approximately four or more seconds before it comes to the end point of Preset Timeline. A pseudo clip "<BLACK>" is not supported.
AX.05	Preview Out Preset	No	No	○	○	○	If you want to set an Out point during the playback, send the command approximately four or more seconds before it comes to the position to set the Out point.
AF.0A	Append Preview Preset	No	No	○	○	○	If you want to execute the command during the playback, send the command approximately four or more seconds before it comes to the end point of Preset Timeline.
A1.32	Set Ganging	No	No	○	○	No	Only switching on/off of sync mode by Instant Ganging is available on T2. (P1 only) Send Data 1: 0 Sync Off 6 Sync On (Channel 2 (bit 1) and Channel 3 (bit 2) ganged)
A0.33	Get Ganging	No	No	○	○	No	
AX.34	Set Ganging Information	No	No	No	No	No	Not supported on T2.

Command		Channel-less mode	Recorder	Player	Sync mode	Fill/Key signal output mode	Supplementary note on T2 operation
A0.35	Get Ganging Information	No	No	No	No	No	Not supported on T2.
AX.11	Erase Segment	No	No	No	No	No	Not supported on T2.
A0.16	ID Loaded Request	No	○	○	○	○	
AX.01	Auto Skip	No	No	○	○	○	

Managing stored clips

Command		Channel-less mode	Recorder	Player	Sync mode	Fill/Key signal output mode	Supplementary note on T2 operation
A0.26	ID Count Request	○	○	○	○	○	
AX.14	List First ID	○	○	○	○	○	
AX.15	List Next ID	○	○	○	○	○	
AX.18	ID Status Request	○	○	○	○	○	
A2.0E	Set Working Folder Request	○	○	○	○	○	
A0.0F	Get Working Folder Request	○	○	○	○	○	
A0.12	IDs Changed List Request	○	○	○	○	○	In and Out points are changed simultaneously, and you can not recognize which point has been changed.
AX.10	Erase ID	○	○	○	○	○	
A0.2A	List First Folder	○	○	○	○	○	

Command		Channel-less mode	Recorder	Player	Sync mode	Fill/Key signal output mode	Supplementary note on T2 operation
A0.2B	List Next Folder	<input type="radio"/>	<input type="radio"/>	<input type="radio"/>	<input type="radio"/>	<input type="radio"/>	
AX.1C	Total/ Available Storage Request	<input type="radio"/>	<input type="radio"/>	<input type="radio"/>	<input type="radio"/>	<input type="radio"/>	
A4.1D	Set Record Duration	No	<input type="radio"/>	No	No	No	Recording duration cannot be changed during the recording operation.
A2.31	Create Folder	<input type="radio"/>	<input type="radio"/>	<input type="radio"/>	<input type="radio"/>	<input type="radio"/>	
A2.28	Rename Folder	<input type="radio"/>	<input type="radio"/>	<input type="radio"/>	<input type="radio"/>	<input type="radio"/>	
A2.29	Delete Folder	<input type="radio"/>	<input type="radio"/>	<input type="radio"/>	<input type="radio"/>	<input type="radio"/>	
A2.25	ID Start Time Request	<input type="radio"/>	<input type="radio"/>	<input type="radio"/>	<input type="radio"/>	<input type="radio"/>	
A2.17	ID Duration Request	<input type="radio"/>	<input type="radio"/>	<input type="radio"/>	<input type="radio"/>	<input type="radio"/>	
AE.30	Replace Edit	No	No	No	No	No	Not supported on T2.
AX.2D	Stripe Timecode	<input type="radio"/>	<input type="radio"/>	<input type="radio"/>	<input type="radio"/>	<input type="radio"/>	In the properties for the clip and playlist, [Replace timecode media:] will be set to [Specify Start Time].
AX.2E	Set Mark In	<input type="radio"/>	<input type="radio"/>	<input type="radio"/>	<input type="radio"/>	<input type="radio"/>	This setting cannot be applied to playlists.
AX.2F	Set Mark Out	<input type="radio"/>	<input type="radio"/>	<input type="radio"/>	<input type="radio"/>	<input type="radio"/>	If you want to set an Out point during the playback, send the command approximately four or more seconds before it comes to the position to set the Out point. This setting cannot be applied to playlists.

Command		Channel-less mode	Recorder	Player	Sync mode	Fill/Key signal output mode	Supplementary note on T2 operation
AX.1A	Get Aspect Ratio Conversion Override	No	No	No	No	No	Not supported on T2.
A2.1B	Set Aspect Ratio Conversion Override	No	No	No	No	No	Not supported on T2.
AE.1E	Set Audio Gain	○	○	○	○	○	It takes several seconds from the time the command has been issued until the time the setting is applied on a loaded clip.
AA.1F	Get Audio Gain	○	○	○	○	○	
C0.28	Abort Transfer ID	○	○	○	○	○	
CX.27	Transfer ID Status Request	○	○	○	○	○	This setting will be applied only on the transfer that has started when Extended Transfer ID command is issued. (Not applied to the transfer that has started in the workstation mode/front panel mode of T2.) type 2 (data containing number of bytes transferred), 3 (data containing number of fields transferred) are not supported.
C2.26	Transfer ID	No	No	No	No	No	Not supported on T2.

Command		Channel-less mode	Recorder	Player	Sync mode	Fill/Key signal output mode	Supplementary note on T2 operation
C2.25	Extended Transfer ID	○	○	○	○	○	<p>Setting of In and Out points is only supported for FFFFFFFF. (The range for the transfer cannot be set.)</p> <p>The setting for the transfer type will be disabled. The transfer type follows the settings in [Transfer] -> [AVI] or [Playlist] on the setting screen.</p> <p>The recommended transfer type is 0x03 (Profile), which is described in “K2_Protocol_developers_Guide” as a sample of transfer via Grass Valley server. Set the clip/playlist name for the transfer source of export.</p> <p>Set the transfer destination as follows.</p> <ul style="list-style-type: none"> • Network Drive:localhost/[n]/[dir]/[file name] <p>For “n”, specify the network drive allocated by [General] -> [Network-3] on the setting screen or the drive connected via USB. Example)localhost/z:/Export/Clip1</p> <ul style="list-style-type: none"> • FTP server:[address]/v:/[bin name]/[file name] <p>For address, specify the address registered in [Hose Name/IP Address] in [FTP Export List] of [General] -> [FTP] on the setting screen. Example)169.254.138.3/v:/Default/Clip1</p>

Command		Channel-less mode	Recorder	Player	Sync mode	Fill/Key signal output mode	Supplementary note on T2 operation
C2.25	Extended Transfer ID	○	○	○	○	○	<p>Set the transfer source of import as follows.</p> <ul style="list-style-type: none"> • [n]:/[dir]/[file name] For “n”, specify the network drive allocated by [General] -> [Network-3] or the drive connected via USB. <p>Set the transfer destination as follows. V:/[bin name]/[clip name]</p>
C2.29	Network Delete	No	No	No	No	No	Not supported on T2.
AX.19	New Copy	○	○	○	○	○	<p>Deep copy is not supported. Setting In and Out points to playlists is not available. Only Shallow and Move are supported.</p>
AX.22	Get Audio Track Labels	No	No	No	No	No	Not supported on T2.
AX.23	Set Audio Track Labels	No	No	No	No	No	Not supported on T2.
A0.36	Get Audio Input Tags	No	No	No	No	No	Not supported on T2.
AA.37	Set Audio Input Tags	No	No	No	No	No	Not supported on T2.
A0.38	Get Audio Output Tags	No	No	No	No	No	Not supported on T2.
AA.39	Set Audio Output Tags	No	No	No	No	No	Not supported on T2.
A2.3A	Get AFD Setting	No	No	No	No	No	Not supported on T2.
A2.3B	Set AFD Setting	No	No	No	No	No	Not supported on T2.

Clip data information

Command		Channel-less mode	Recorder	Player	Sync mode	Fill/Key signal output mode	Supplementary note on T2 operation
AA.08	Set Clip Data	No	No	No	No	No	Not supported on T2.
AA.13	Clip Data Request	○	○	○	○	○	If Send Data 1 is 'C', Compression Type and Video Format are not supported. If Send Data 1 is 'E', this setting is not available.
A2.09	Get Thumbnail	○	○	○	○	○	A JPEG data with the size of 160 x 90 will be returned.

Flags

Flags	Command	Availability	Note
Status byte 0			
bit0:	Local	○	
bit1:	Remote+Local	○	
bit2:	Hard Error	○	
bit3:	General Error	○	
bit4:		—	
bit5:	Cassette Out	○	Always 0
bit6:		—	
bit7:	Busy	○	
Status byte 1			
bit0:	Play	○	
bit1:	Record	○	
bit2:	Fast Forward	○	
bit3:	Rewind	○	
bit4:	Eject	○	Always 0
bit5:	Stop	○	
bit6:	Tension Release	○	Always 0
bit7:	Standby On	○	Always 1
Status byte 2			
bit0:	Cue Complete	○	
bit1:	Still	○	
bit2:	Direction	○	
bit3:	Variable Play	○	
bit4:	Jog	○	
bit5:	Shuttle	○	
bit6:		—	
bit7:	Servo Lock	○	
Status byte 3			
bit0:	In Preset	○	
bit1:	Out Preset	○	
bit2:	Specified Folder Exist	○	
bit3:	Invalid Folder Name	○	
bit4:	Folder Deletion Failed	○	
bit5:	Jog Reject	○	
bit6:	Source Missing	○	
bit7:	Auto Mode	○	

Flags	Command	Availability	Note
Status byte 4			
bit0:	Preroll	○	
bit1:	Event Schedule Failed	○	
bit2:		—	
bit3:		—	
bit4:	Mute	○	
bit5:	Loop Playback Mode	○	
bit6:	EE On	○	
bit7:		—	
Status byte 9			
bit0:	Preview In Preset	○	
bit1:	Preview Out Preset	○	
bit2:	Folder Not Found	○	
bit3:	Disk Overflow	○	
bit4:	Metadata Not Found	No	
bit5:	Clips Dropped	○	
bit6:	Out Preset Failed	○	
bit7:	Overwrite Clip Name	○	
Status byte A			
bit0:	ID Not Found	○	
bit1:	Timecode Not Found	○	
bit2:	Transfer ID Complete	○	
bit3:	Transfer ID Abort Complete	○	
bit4:	Movie Delete Complete	○	
bit5:	Transfer ID Failed	○	
bit6:	Transfer ID Abort Failed	○	
bit7:	movie Delete Failed	○	
Status byte D			
bit0:	Time Of Day	○	
bit1:	Widescreen Mode	○	
bit2:	Drop Frame	○	
bit3:	VITC	○	
bit4:	Timer	○	
bit5:	LTC	○	
bit6:	Tape End	○	
bit7:	Tape Top	○	

BVW command list

The BVW commands available when controlling an external controller from T2 in the Recorder-VTR mode are listed in the following tables.

The commands with the “○” mark are available on the optional action as DEVICE, and if mentioned in the RETURN column, RETURN + DATA is returned, and if not mentioned, 10 01 ACK is returned. The commands with the “△” mark return ACK or return RETURN as STATUS, but the action will not be performed.

Command			RETURN			
00	11	DEVICE TYPE REQUEST	12	11	DEVICE TYPE RETURN	○
20	00	STOP				○
20	01	PLAY				○
20	02	RECORD				○
20	04	STANDBY OFF				○
20	05	STANDBY ON				○
20	10	FAST FWD				○
2X	11	JOG FWD				○
2X	12	VAR FWD				○
2X	13	SHUTTLE FWD				○
2X	20	REWIND				○
2X	21	JOG REV				○
2X	22	VAR REV				○
2X	23	SHUTTLE REV				○
24	31	CUE UP WITH DATA				○
20	54	ANTI-CLOG TIMER DISABLE				△
20	55	ANTI-CLOG TIMER ENABLE				△
44	00	TIMER-1 PRESET				○
40	08	TIMER-1 RESET				○
41	36	TIMER MODE SELECT				○
61	0C	CURRENT TIME SENSE	74	00	TIMER-1 DATA	○
			74	04	LTC TIME DATA	○
			78	04	LTC TIME & UB DATA	○
			74	05	LTC UB DATA	○
			74	06	VITC TIME DATA	○
			78	06	VITC TIME & UB DATA	○
			74	07	VITC UB DATA	○
			70	0D	REQUEST TIME MISSING	○
61	20	STATUS SENSE	7X	20	STATUS DATA	○
60	2E	COMMAND SPEED SENSE	71	2E	COMMAND SPEED DATA	○
60	36	TIMER MODE SENSE	71	36	TIMER MODE DATA	○

* Start Delay value = 10 (*16 hexadecimal)

BVW list supporting remote mode

The BVW commands available when controlling T2 from an external controller in the Recorder-remote mode and Player-remote mode are listed in the following table.

○: Supported, △: Not all supported, ×: Not supported

Command	R1	Px
DEVICE TYPE REQUEST	○	○
STOP	○	○
PLAY, SYNC PLAY	×	○
RECORD	○	○
STANDBY OFF	○	○
STANDBY ON	×	○
FAST FWD	×	○
JOG FWD	×	○
VAR FWD	×	○
SHUTTLE FWD	×	○
REWIND	×	○
JOG REV	×	○
VAR REV	×	○
SHUTTLE REV	×	○
CUE UP WITH DATA	×	○
ANTI-CLOG TIMER DISABLE	△	△
ANTI-CLOG TIMER ENABLE	△	△
TIMER-1 PRESET	○	○
TIMER-1 RESET	○	○
TIMER MODE SELECT	○	○
CURRENT TIME SENSE	○*1	○
TIMER-1 DATA	○	○
LTC TIME DATA	○	○
LTC TIME & UB DATA	○	○
LTC UB DATA	○	○
VITC TIME DATA	○	○
VITC TIME & UB DATA	○	○
VITC UB DATA	○	○
REQUEST TIME MISSING	○	○
STATUS SENSE	○	○
COMMAND SPEED SENSE	○	○
TIMER MODE SENSE	○	○
REC	○	×

*1 If you query the timecode, Recorder returns the timecode currently being input. For CURRENT TIME SENSE, the type of timecode to query can be specified (LTC/VITC). Whichever is specified, the timecode type set in T2 (the timecode type selected in [Select Timecode] in [R1] -> [Timecode & Remote] on the setting screen) is returned.

RS422 input/output pin

RS422 input/output pins are as follows.

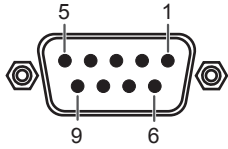

**R1 (Recorder-VTR mode)
D-Sub 9pin**

Pin	Signal
1	GND
2	RECEIVE-
3	TRANSMIT+
4	GND
5	NC
6	GND
7	RECEIVE+
8	TRANSMIT-
9	GND

**R1/Px (remote mode)
D-Sub 9pin**

Pin	Signal
1	GND
2	TRANSMIT-
3	RECEIVE+
4	GND
5	NC
6	GND
7	TRANSMIT+
8	RECEIVE-
9	GND

GPIO input/output pin

GPIO input/output pins are as follows.

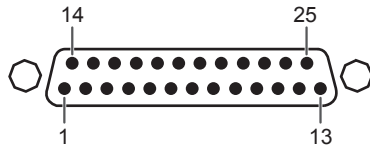

Pin	Signal
1	NC
2	NC
3	Output 1
4	Output 2
5	Output 3
6	Output 4
7	Output 5
8	Output 6
9	Output 7
10	Output 8
11	GND
12	NC
13	NC

Pin	Signal
14	NC
15	GND
16	Input 1
17	Input 2
18	Input 3
19	Input 4
20	Input 5
21	Input 6
22	Input 7
23	Input 8
24	NC
25	NC
Frame	GND

NOTE • Only GPI Output 1 to 8 and Input 1 to 8 are available on T2. The pins for which “NC” is indicated in the “Signal” column are not used.